

Cable System. For Orthopaedic Trauma Surgery.

Technique Guide



Table of Contents

Introduction	Overview	2
	AO Principles	4
	Indications and Contraindications	5
Surgical Technique	Standard Cerclage Technique	6
	Tension-band Technique on the Olecranon	15
	Tension-band Technique on the Patella	18
	Trochanteric Reattachment Device	21
	Cleaning Instruments	31
Product Information	Implants	32
	Instruments	34
	Cable System in Vario Case	36

 Image intensifier control

Warning

This description alone does not provide sufficient background for direct use of the instrument set. Instruction by a surgeon experienced in handling these instruments is highly recommended.

Reprocessing, Care and Maintenance of Synthes Instruments

For general guidelines, function control and dismantling of multi-part instruments, please refer to: www.synthes.com/reprocessing

Cable System. For Orthopaedic Trauma Surgery.

Description

The Synthes Cable System is primarily a cerclage system that consists of two different-sized cerclage cables with crimp in three different materials, and new instruments for applying the cable assembly. The cable assemblies are available for stainless steel and titanium implant indications. They are designed for use with the Cerclage Positioning Pins (for LC-DCP and LCP) and Cerclage Eyes (only available for screws with hex recess). The Synthes Cable System is fully compatible with all Synthes plates and screws.

Ergonomically designed instruments

A primary goal of development was an ergonomic, compact instrument design which simplifies handling and decreases application errors.

Multifunctional

A variety of articles (implants and instruments) make the cable system a very versatile system, enabling it to be used for a wide range of applications (e.g. periprosthetic fractures, temporary reduction).

Easy and safe surgical technique

All implants and instruments were optimized without compromise for the specific tasks of a cable system. This simplifies the surgical technique (e.g. no contouring of plates necessary) and makes them easier and safer to use.

Application

Compatible with Synthes implants

The Cable system is compatible with the existing Synthes plates and screws, both in stainless steel and titanium.



Temporary fixation to support reduction

For the temporary fixation of a cerclage cable, the cable tensioner can be removed without losing tension thanks to the temporary Tension Holder.

Easy and safe crimping

A ratchet mechanism controls the amount of crimp and deformation. The crimper automatically releases when the cable is crimped (no overcrimping or undercrimping possible).



AO Principles

In 1958, the AO formulated four basic principles which have become the guidelines for internal fixation:¹

Anatomic reduction

Fracture reduction and fixation to restore anatomical function.

Stable fixation

Stability by fixation with the cable system in combination with Synthes Implants as required by the nature of the fracture and the injury.

Preservation of blood supply

The variety of cables provide better access, enabling the cerclage cable to be passed around different sized and shaped bones while limiting tissue trauma and periosteal stripping and thus preserving the blood supply.

Early mobilization

When implanted, the cables and implants provide stable fracture fixation that allows early, pain-free mobilization.

¹M.E. Müller, M. Allgöwer, R. Schneider, and R. Willenegger (1991)
AO Manual of Internal Fixation, 3rd Edition. Berlin: Springer.

Indications and Contraindications

Indications

- Orthopaedic trauma surgery (incl. periprosthetic fractures, femur fractures, olecranon fractures, patella fractures, humerus and ankle fractures)
- Acromioclavicular dislocation
- Hip and acetabular fractures
- Prophylactic banding in total joint replacements
- Temporary fixation during open reductions
- Reattachment of the greater trochanter following osteotomy in total hip arthroplasty or fractures

Contraindications

The cerclage cable \varnothing 1.0 mm may not be used for fractures of the femur, or for prophylactic banding during total joint replacements.

Standard Cerclage Technique

The following standard cerclage technique is explained using the example of a periprosthetic femoral fracture.

1

Position patient and reduce fracture

Position the patient for the respective surgical approach, and reduce the fracture.

2

Choose the appropriate cable passer

Instruments

391.103	Cable Passer, medium, curved
391.104	Cable Passer, large, curved
391.105	Cable Passer medium
391.106	Cable Passer, medium, 45° angle
391.107	Cable Passer large

Optional

391.108	Cable Passer, large, 45° angle
---------	--------------------------------

Select the appropriate cable passer. The size and shape of the cable passer depends upon the circumference of the bone and access to the site. Select a cable passer that will allow the instrument to pass around the bone without causing significant damage to soft tissues or excessive stripping of the periosteum.

3

Pass the cable around the bone

Pass the cable passer around the bone. Thread the free end of the cable into the end-hole of the cable passer until the cable exits through the shaft hole. Remove the cable passer leaving the cable wrapped around the bone.

Note: Do not thread the cerclage cable through the shaft hole since the crimp will prevent removal of the cable passer.

If plates are employed, you may use cerclage positioning pins for LCP, DCP and LC-DCP (see step 4A, page 8), cerclage eyes (see step 4B, page 9) or threaded cerclage positioning pins for LCP 3.5/4.5 (see step 4C, page 10).

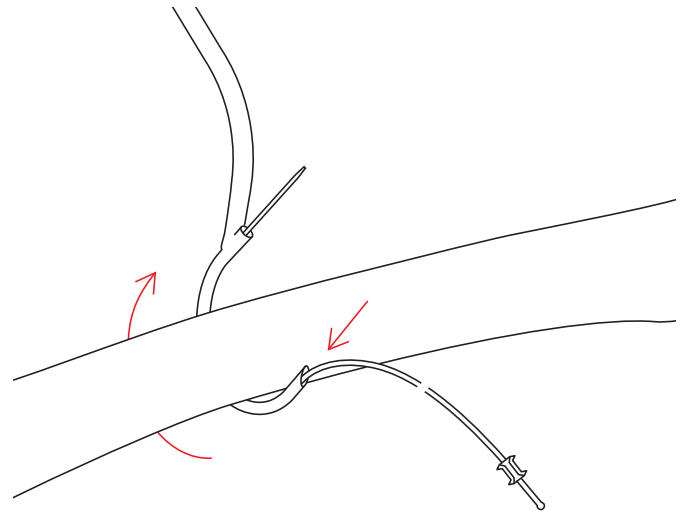

4A

Use of cerclage positioning pins for LCP, DCP and LC-DCP

Instruments

X98.837/839	Cerclage Positioning Pin for LCP 3.5/4.5 and LC-DCP 3.5/4.5
310.310	Drill Bit \varnothing 3.2 mm, length 145/120 mm, 2-flute, for Quick Coupling
323.460	Universal Drill Guide 4.5/3.2, for neutral and load position

Cerclage positioning pins are used for periprosthetic fracture fixation with plates when screws are not an option. The positioning pins guarantee the stable positioning of the cable on the plate.

1 Position plate and drill pilot hole

Position the plate (LCP 3.5/4.5, LC-DCP and DCP 4.5 wide or narrow) on the bone. Choose the site of the positioning pin, and drill a pilot hole \varnothing 3.2 mm in the cortical bone in the centre of the plate hole with aid of the universal drill guide.

2 Mount cerclage positioning pin

Mount a positioning pin on the cable and advance it up to the crimp. Thread the cable through the end-hole of the cable passer, and pass it around the bone.

3 Insert cerclage positioning pin in plate hole

Instrument

391.885	Holding Forceps for Cerclage Eyes and Positioning Pin
---------	---

Insert the positioning pin into the pilot hole, either by hand or using the holding forceps.

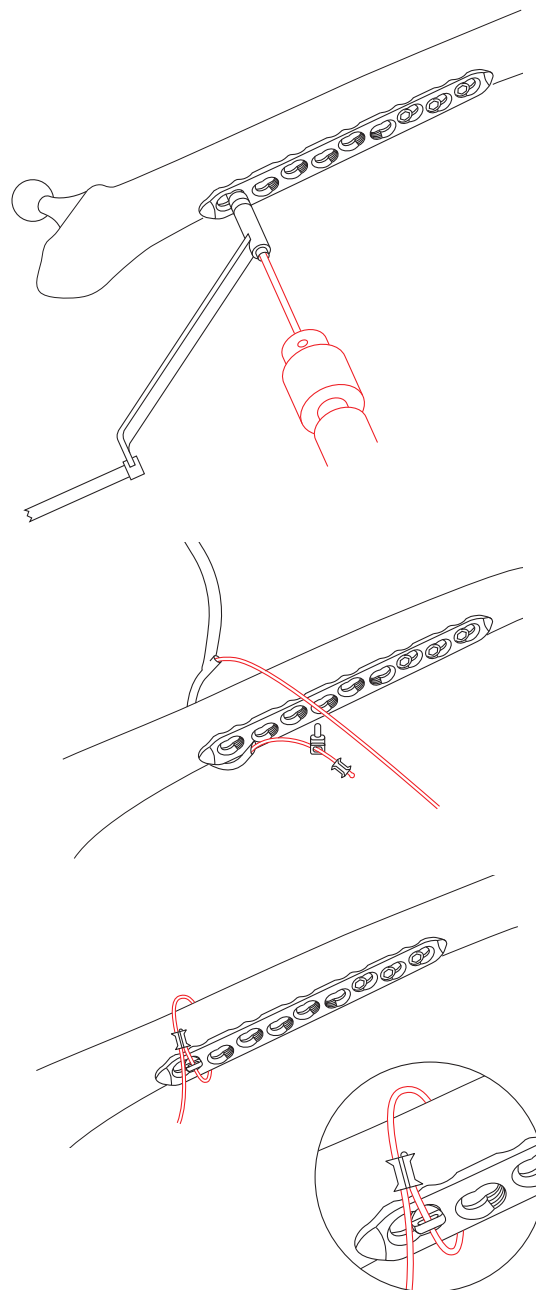

4B

Use of cerclage eyes for screws

Instruments

OX.221.002.05	Cerclage Eyes for Screws Ø 3.5 mm Stardrive and hexagonal socket, pack of 5 units
OX.221.003.05	Cerclage Eyes for Screws Ø 4.5 mm Stardrive and hexagonal socket, pack of 5 units
OX.221.004.05	Cerclage Eye for Hexagonal Socket, Ø 4.0 mm, cannulated, pack of 5 units

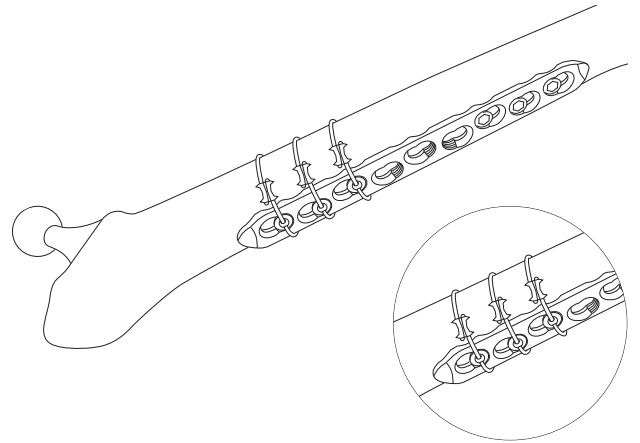

Cerclage eyes are used in cases where screws are unable to get a sufficient grip (e.g. in periprosthetic fractures) or where monocortical screws are used with prostheses.

1 Mount cerclage eye

Mount a cerclage eye on the cable and advance it up to the crimp. Thread the cerclage cable through the end-hole of the cable passer, and pass it around the bone.

2 Insert cerclage eye

Instrument

391.885	Holding Forceps for Cerclage Eyes and Positioning Pin
---------	--

Insert the cerclage eye into the recess of the screw using the holding forceps.

Note: The correct material composition is important. Use a stainless steel cable only with stainless steel implants, and the CoCr cable only with Titanium implants.

4C

Use of threaded cerclage positioning pins for LCP

Instruments

X98.838.01	Threaded Cerclage Positioning Pins for LCP 3.5
X98.803.01	Threaded Cerclage Positioning Pins for LCP 4.5

Threaded cerclage positioning pins for LCP are used for LCP plates 3.5 and 4.5/5.0, where the locking screws cannot sufficiently grip. The cerclage positioning eyes guarantee the stable positioning of the cable on the plate.

1 Mount the threaded cerclage positioning pin for LCP

Fix the plate with LCP screws to secure the position of the plate. Define the position of the positioning pin on the plate, and manually screw in the positioning pin into the threaded part of the LCP combi-hole.

2 Mount the cable

Thread the cable through the end-hole of the cable passer, and pass it around the bone. Then pass the cable through the hole of the cerclage positioning pin.

Note: The correct material composition is important. Use a stainless steel cable only with stainless steel implants, and the CoCr cable only with TAN implants.

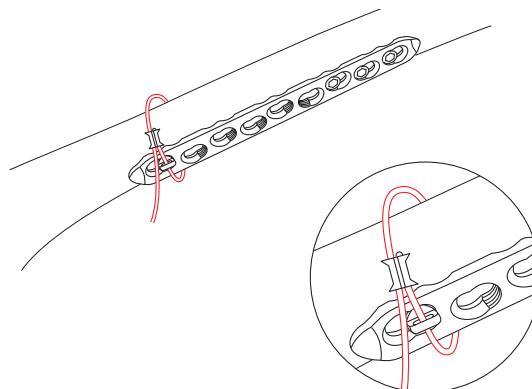

5

Position cable crimp

Insert the end of the cable through the free hole of the crimp, and place the crimp in the desired position on the bone. When placing the crimp, ensure that it is covered by soft tissue and securely anchored in the bone. The four points on the underside of the crimp must contact the bone, and the smooth side must face upwards.

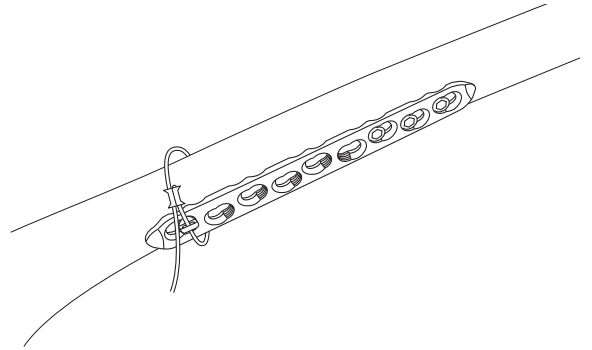

6

Insert cerclage cable into the cable tensioner

Instruments

391.884	Tension Holder, for temporary use
391.883	Attachment Bit for Tension Holder
391.201	Cable Tensioner

Mount the temporary tension holder and the attachment bit on the cable tensioner. To enable the cerclage cable to be inserted into the cable tensioner, turn the fluted knob at the end of the tensioner counterclockwise as far as possible. Insert the cerclage cable into the cable tensioner, and advance the attachment bit up to the crimp.

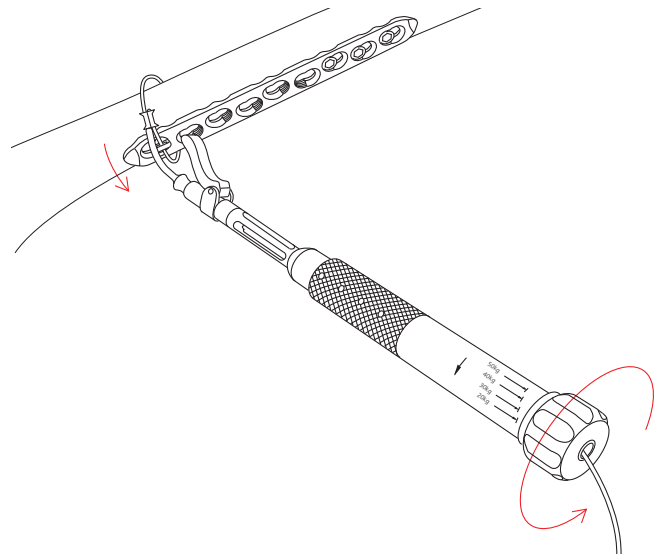

7

Tension cerclage cable

Turn the fluted knob on the cable tensioner until the desired tension is reached. The tension is shown by the markings on the tensioner (20–50 kg).

If the cerclage cable is tensioned above the specified level, it may tear out of the crimp or cut through or crush osteoporotic bone.

Note: The tension of the cerclage cable should not exceed 40 kg (for the cable \varnothing 1.0 mm) and 50 kg (for the cable \varnothing 1.7 mm).

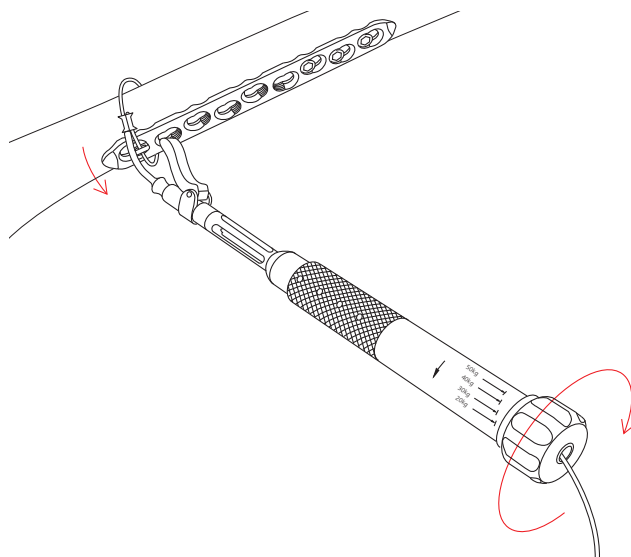

8

Temporary fixation (optional)

Instrument

391.884 Tension Holder, for temporary use

To temporarily fix a cerclage cable, the cable tensioner can be removed without causing loss of tension thanks to the temporary tension holder.

Pull back the lever of the cam lock on the temporary tension holder, and loosen and remove the cable tensioner (see step 10, page 13). Using this procedure, any cerclage cable can be retensioned and/or repositioned before definitive fixation.

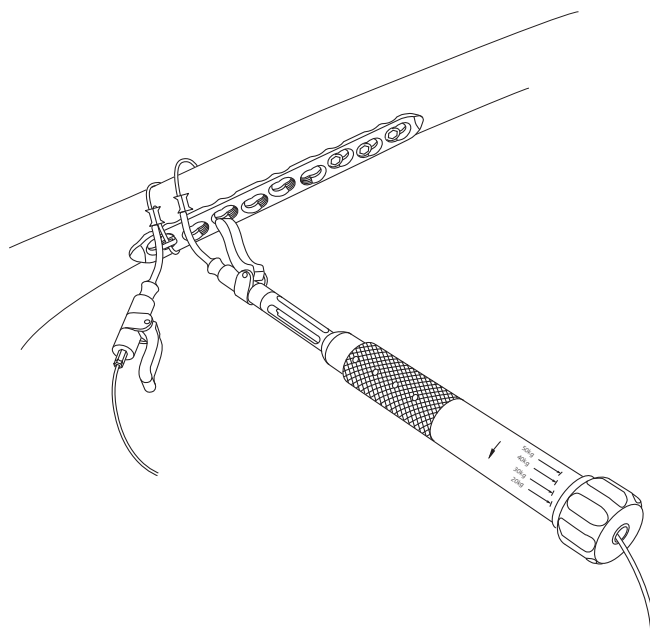

9

Secure cerclage cable with cable crimp

Instrument

391.882	Cable Crimper
---------	---------------

When the desired cable tension is reached, the cerclage cable can be secured with the crimp. Place the jaws of the cable crimper on the crimp, ensuring that the crimp is centred and is correctly held in the crimper jaws. Pull the inner start lever first, then squeeze the outer handles to complete crimping. The toothed mechanism of the cable crimper establishes the appropriate compression pressure for securing the crimp.

Note: Incorrectly placing the cable crimper can lead to crimp failure.

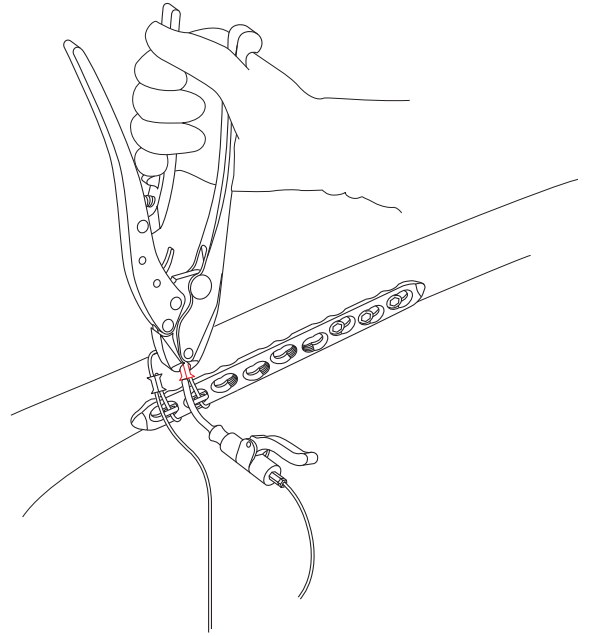

10

Remove cable tensioner

When the crimp – and thus the cerclage cable – is secured, turn the fluted knob on the cable tensioner as far as possible, and remove the tensioner. If the temporary tension holders are wed, push the lever of the cam lock forward, and pull the holder off the cable.

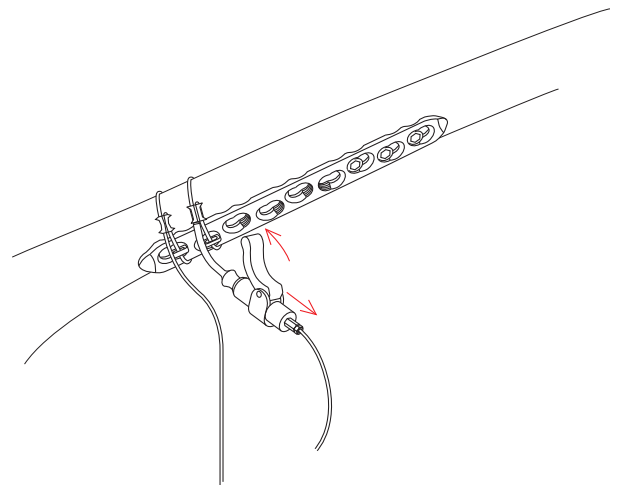

11

Cut cable

Instrument

391.905	Cable Cutter, standard
or	
391.906	Cable Cutter, large

Cut the loose end of the cable using the cable cutter. Position the cutting jaws very close to the crimp, and make the cut in one action to produce a clean cut. Ensure that the adjacent cerclage cables do not get damaged.

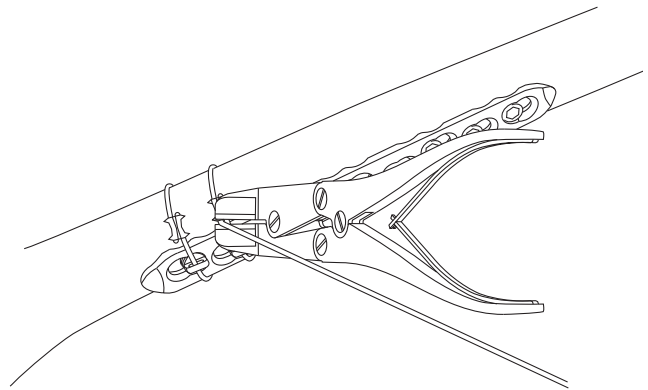

Tension-band Technique on the Olecranon

The principle of the tension-band technique is mainly employed in avulsion fractures and fractures of the olecranon or patella. Fractures or osteotomies of the greater trochanter and avulsion fractures of the medial and lateral malleolus can also be treated with this technique.

1

Position patient and reduce fracture

Position the patient and reduce the fracture.

2

Insert Kirschner wires

Using a drill guide, insert two parallel Kirschner wires in line with the longitudinal axis of the olecranon. The Kirschner wires can be drilled into the anterior cortical bone of the ulna, or down to the medullary cavity. Predrilling may be indicated for hard bone.

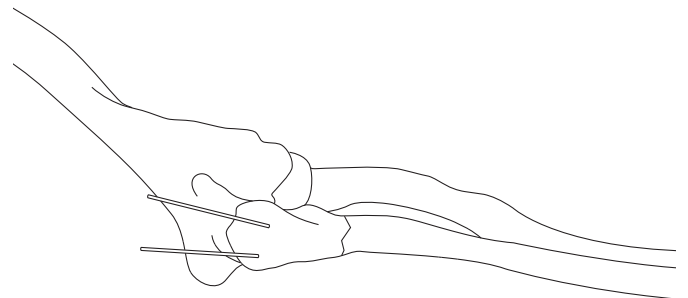

3

Drill hole for cerclage cable

Instrument

310.190	Drill Bit \varnothing 2.0 mm, length 100/75 mm, 2-flute, for Quick Coupling
---------	---

For the cable in the distal fragment, drill a \varnothing 2.0 mm hole perpendicular to the longitudinal axis of the ulna and distal to the fracture site. The distance between the fracture site and the drill hole (B) should match the length of the proximal fracture fragment (A). The drill must only just penetrate the second layer of cortical bone.

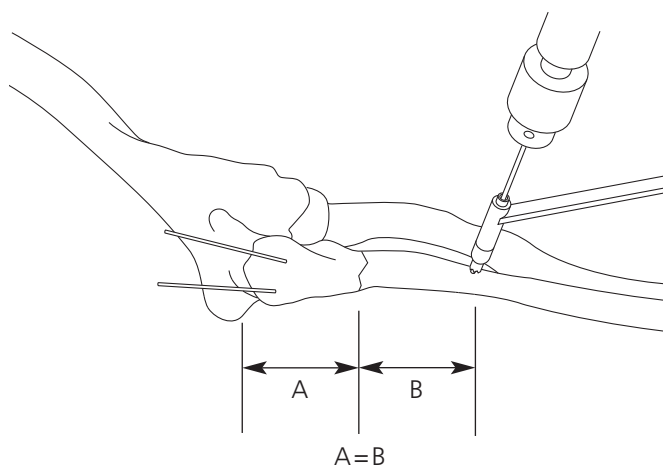

4

Create the tension band

Instrument

X98.800.01	Cerclage Cable with Crimp \varnothing 1.0 mm
------------	--

Position the crimp of the cerclage cable \varnothing 1.0 mm on the ulna parallel with its longitudinal axis. Guide the cerclage cable through the drill hole and around the Kirschner wires. Pass the free cable end across the positioned cerclage cable to produce a figure-eight loop, and insert it into the free hole of the crimp.

Alternatively, one or two screws (solid or cannulated) with cerclage eyes may be used instead of the Kirschner wires.

For tensioning, crimping and cutting of the cable, see steps 7–11 of the standard technique, page 12 ff.

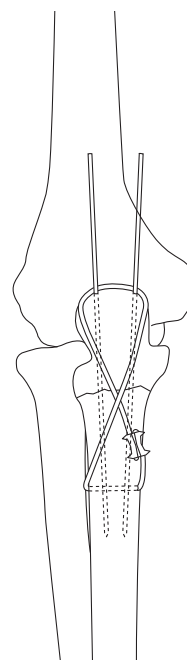

Note: The correct material composition is important. Use a stainless steel cable only with stainless steel implants, and the CoCr and Titanium cable only with Titanium implants.

5

Cut and anchor Kirschner wires

Instruments

391.820	Wire Bending Pliers, length 155 mm, for Wires up to \varnothing 1.25 mm
392.000	Bending Iron for Kirschner Wires, for Wires up to \varnothing 1.25 mm

Slightly retract the Kirschner wires. Cut them at an oblique angle so that the sharp ends can be bent to form small hooks using the wire bending pliers. Using the bending iron for Kirschner wires and a hammer, tap the hooks into the bone. Ensure that the hooks secure the cerclage cable.

Note: Do not cut the Kirschner wires with the cable cutter since this can damage the cutting edges.

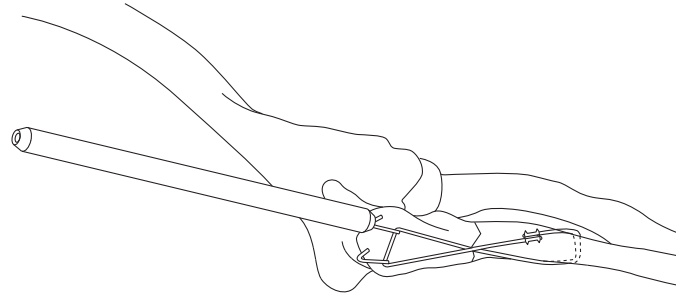

Tension-band Technique on the Patella

1

Reduce fracture

Instruments

310.190	Drill Bit \varnothing 2.0 mm, length 100/75 mm, 2-flute, for Quick Coupling
X92.160	Kirschner Wire \varnothing 1.6 mm with trocar tip, length 150 mm

Tilt the distal fracture fragment to expose the fracture surfaces of both fragments. Using the drill bit, drill two parallel holes in a retrograde direction through the proximal fragment. Insert the Kirschner wire into each hole with the blunt end to the fore, and advance it into the fracture surface until it emerges in front of the quadriceps. Ensure that the Kirschner wire tips remain completely in the proximal fragment.

Reduce the fracture using a reduction forceps with points, and secure provisionally. Check the anterior cortical bone and the articular surface to ensure that the fracture is correctly reduced.

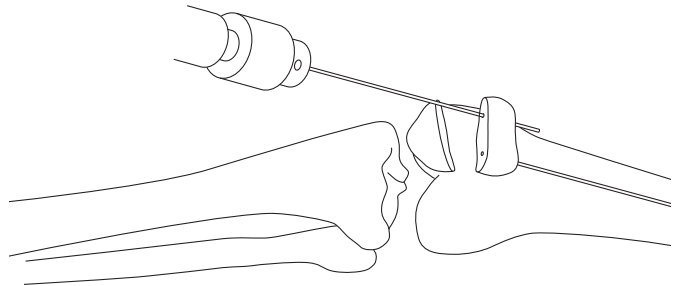

2

Insert Kirschner wires into the distal fragment

Instrument

310.190	Drill Bit \varnothing 2.0 mm, length 100/75 mm, 2-flute, for Quick Coupling
---------	---

Gradually insert the Kirschner wires into the distal fragment and advance at least as far as 1 cm beyond the distal pole of the patella. Check the reduction and provisional fixation.

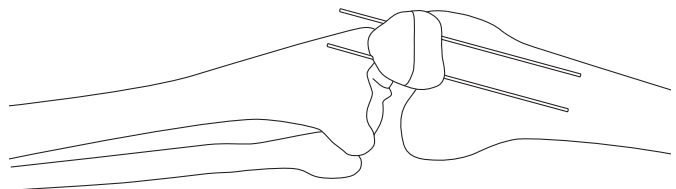

3

Cut the proximal ends of the Kirschner wires

Instrument

391.820	Wire Bending Pliers, length 155 mm, for Wires up to \varnothing 1.25 to 2.5 mm
---------	---

Cut the proximal ends of the Kirschner wires at an oblique angle to produce sharp ends. Using the wire bending pliers, bend the proximal ends of the Kirschner wires to form hooks.

Note: Do not cut the Kirschner wires with the cable cutter since this can damage the cutting edges.

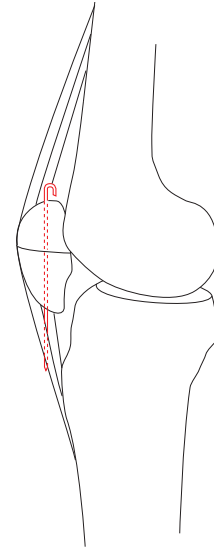

4

Create the tension band

Instrument

X98.800.01	Cerclage Cable with crimp \varnothing 1.0 mm
------------	--

Position the crimp of the cerclage cable on the lateral or medial side, proximal to the pole of the patella. Pass the cable deep to the quadriceps and patellar tendons around the Kirschner wires. Pull the free cable end beneath the positioned cable to produce a figure-eight loop, and insert it into the free hole of the crimp.

For tensioning, crimping and cutting of the cable, see steps 7–11 of the standard technique, pages 12 ff.

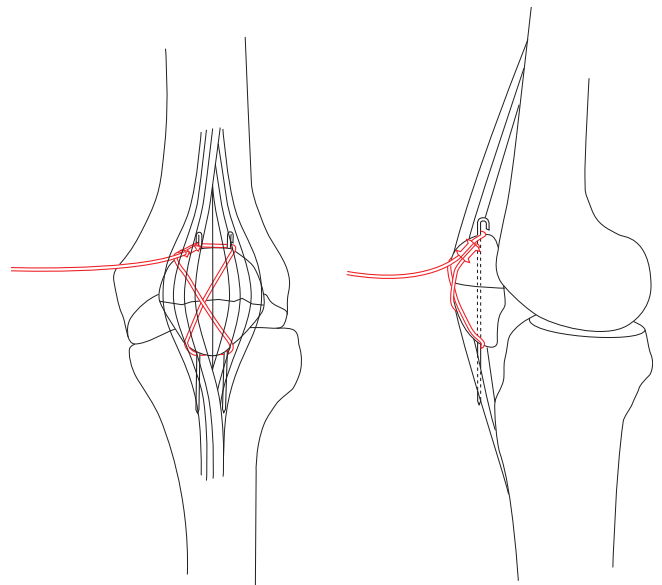

5

Cut and anchor Kirschner wires

Instrument

392.000	Bending Iron for Kirschner Wires
---------	----------------------------------

Using the Bending Iron for Kirschner Wires and a hammer, tap the hooks into the bone. Ensure that the hooks secure the cerclage cable.

Cut the projecting distal ends of the Kirschner wires approx. 1 mm from the bone.

Note: Do not cut the Kirschner wires with the cable cutter since this can damage the cutting edges.

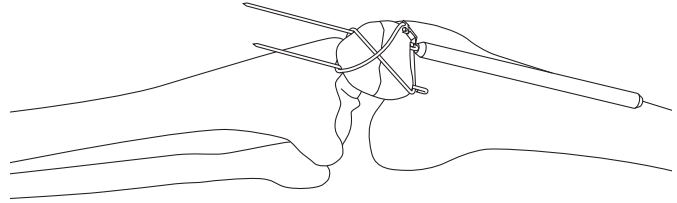

Trochanteric Reattachment Device

1

Reduce the trochanteric fragment

Instruments

498.806	TRD – Trochanteric Reattachment Device, titanium
498.807	TRD – Trochanteric Reattachment Device, large, titanium
391.919	Impactor for TRD, for Cable System

Hold the femur in a slightly flexed, internally rotated, and abducted position. Reduce the trochanteric fragment into the desired position using standard bone reduction forceps, a common bone hook, or trochanter forceps. The Trochanteric Reattachment Device attached to the Impactor can also be used to reduce the trochanteric fragment.

Note: When reducing the greater trochanter, it is critical to make sure that there is a good bed of bone upon which the trochanter will be fixed.

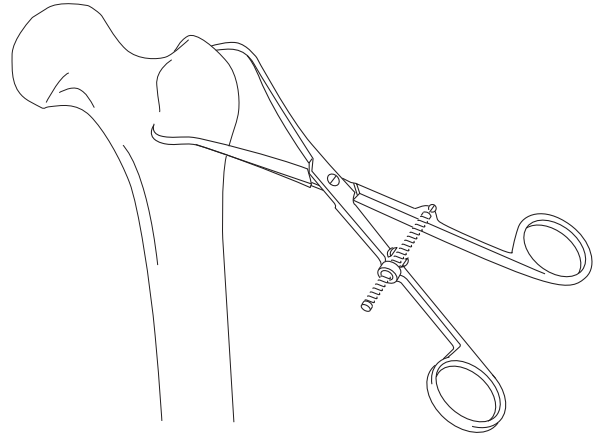

2

Prepare the Trochanteric Reattachment Device (TRD)

Remove the TRD from its package and pull the free end of each cable out of it.

Note: It is very important to plan the direction from which the cables will be tensioned. If necessary, change the direction in which the cables pass through the TRD to facilitate access.

To change the direction of the cables:

- 1 Hold the TRD in the palm of one hand, ensuring that the free ends of the cables remain in the sterile field.
- 2 Place one finger lengthwise over the center of the TRD (directly over the crimps) to prevent the crimps from moving.
- 3 Remove one cable from the TRD.
- 4 Thread it through the TRD and crimp in the opposite direction.
- 5 Repeat this process for the other cables.

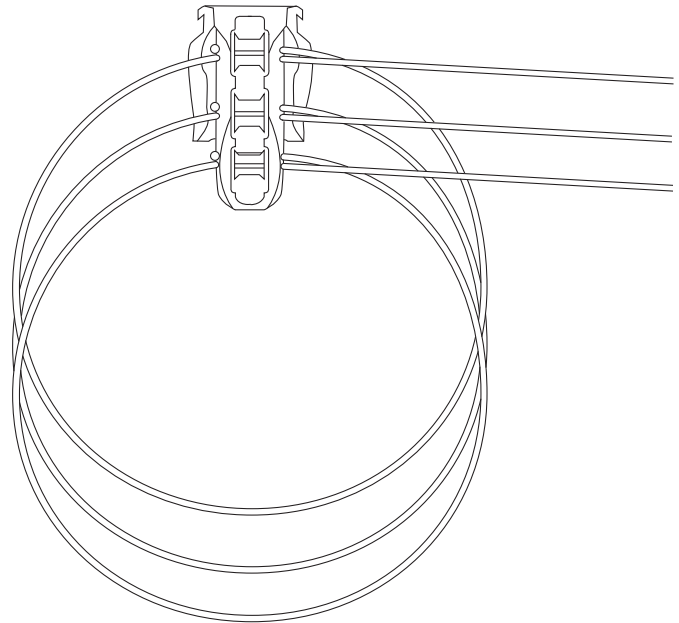

3

Attach the impactor

Instrument

391.919 Impactor for TRD, for Cable System

Turn the collar of the Impactor counterclockwise until the jaws are fully open.

Place the TRD on a flat surface and position the impactor over the flat area on the proximal end of the TRD, just above the most proximal crimp. When the jaws are closed, they should grip the TRD in the small notches on either side of the device. Turn the collar of the impactor clockwise until the jaws close and hold the TRD firmly.

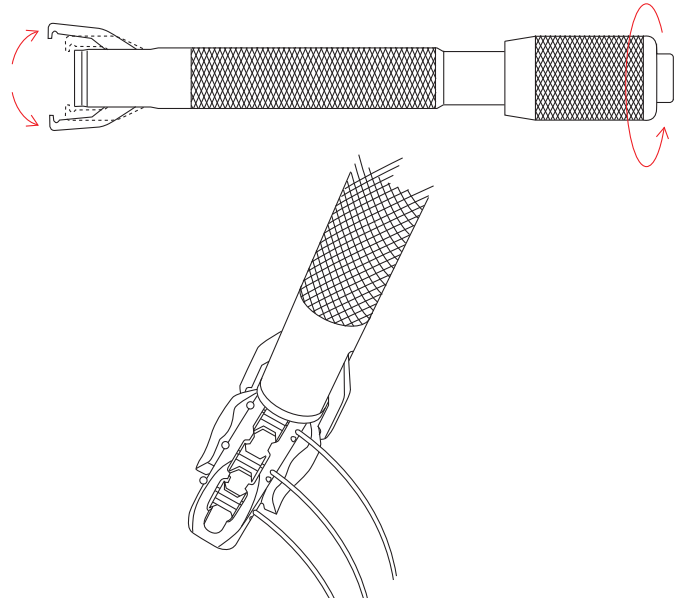

4

Position the TRD

Position the TRD over the trochanter so that the upper hooks engage and wrap around the superior portion of the trochanter.

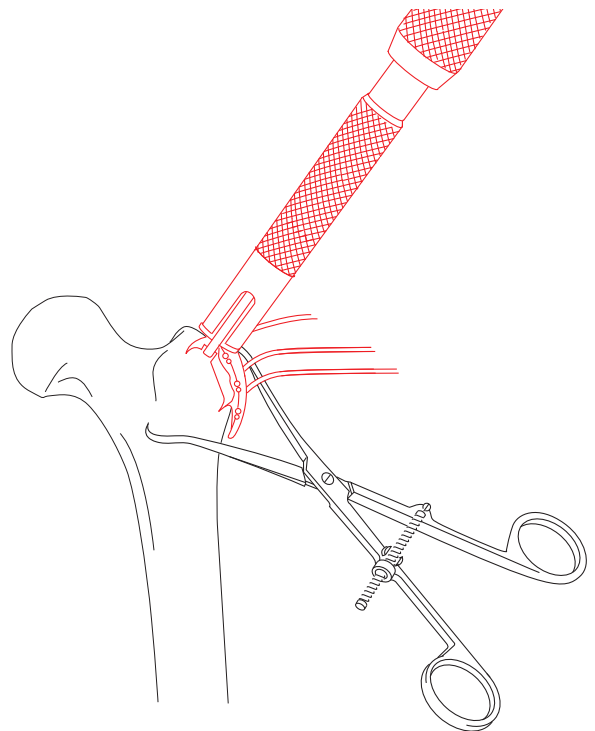

5

Impact the TRD

Using a hammer, impact the TRD onto the greater trochanter, ensuring that it is fully seated. Impaction should always occur in the distal direction to prevent the trochanteric fragment from slipping proximally.

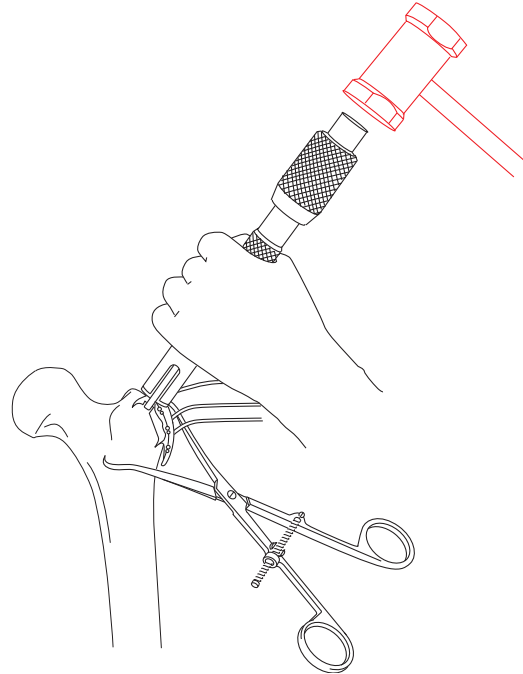

6

Select the cable passer

Instrument

188.215	Orthopaedic Cable Instrument Set
---------	----------------------------------

Select the appropriate cable passer from the Orthopaedic Cable Instrument Set. The size and shape of the cable passer depend on the circumference of the bone and access to the surgical site. Select a cable passer that will allow passage of the instrument around the bone without causing significant damage to soft tissue or excessive stripping of the periosteum.

Note: The cables should not be passed around a prosthesis.

7

Pass the cable

Place the cable passer around the bone. Thread the free end of a cable into the end-hole of the cable passer until the cable exits through the shaft hole.

Notes

- The middle cable should be threaded first.
 - Do not thread the cable into the shaft hole of the cable passer, since the cable crimp and TRD, which are attached to the other end of the cable, will prevent release of the cable passer.
-

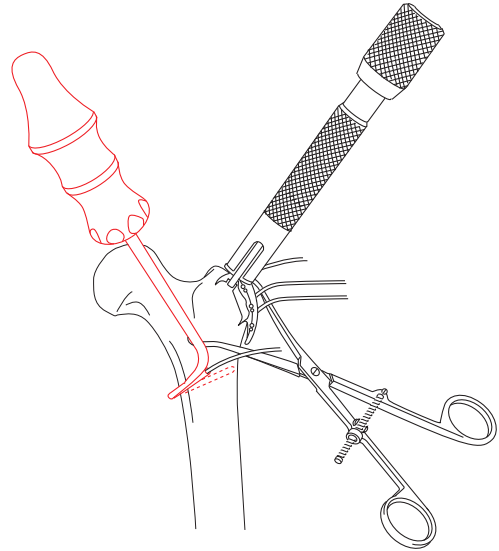

8

Position the cable

Remove the cable passer, leaving the cable wrapped around the bone.

Thread the free end of the cable through the opposite side of the TRD, through the open hole of its respective cable crimp, and back out through the other side of the TRD.

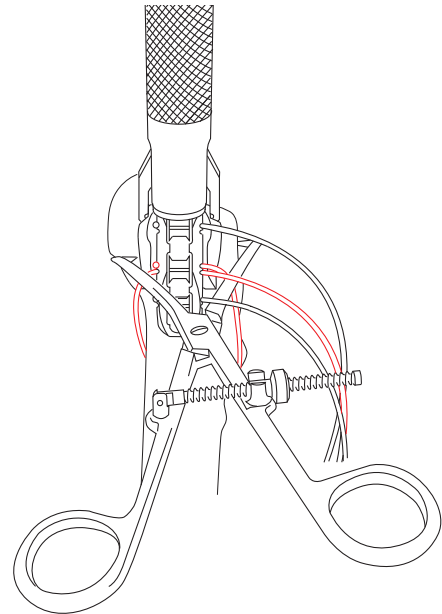

9

Insert cerclage cable into the cable tensioner

Instruments

391.884	Tension Holder, for temporary use
391.883	Attachment Bit for Tension Holder
391.201	Cable Tensioner

Mount the temporary tension holder and the attachment bit on the cable tensioner. To enable the cerclage cable to be inserted into the cable tensioner, turn the fluted knob at the end of the tensioner counterclockwise as far as possible. Insert the cerclage cable into the tensioner, and advance the attachment bit up to the crimp (see step 6 page 11).

10

Position the cable tensioner assembly

Beginning with the central cable, thread the cable through the cable tensioner assembly. Advance the tensioner assembly along the cable until the attachment bit rests against the TRD. By hand, carefully take up any slack in the cable through the back of the cable tensioner.

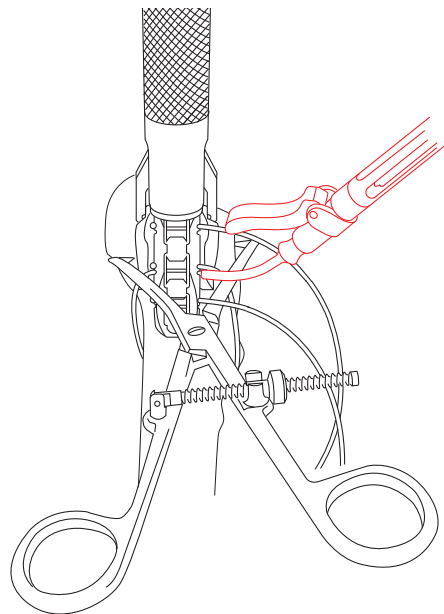

11

Tension the cables

Turn the fluted knob on the tensioner until the desired tension is reached. The tension is shown by the markings on the tensioner. These lines indicate tension levels from 20 to 50 kg (see step 7 page 12).

Note: Take care not to exceed 50 kg of tension. Applying more tension may cause the cable to cut through soft or osteoporotic bone.

12

Lock tensioned cable

When the desired tension is reached, the temporary tension holder may be engaged to hold tension in the cable while additional cables are placed. Pull back the lever of the cam lock into locked position.

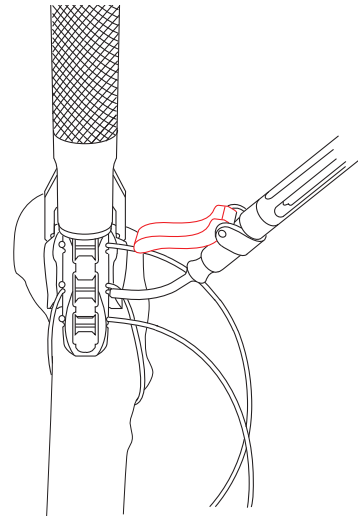

13

Remove tensioner and impactor

Prior to removing the cable tensioner from the temporary tension holder, turn the fluted knob of the tensioner as far as possible.

Then remove the tensioner and the impactor from the TRD.

Note: There will be slight resistance when turning the knob for the last few turns before the tensioner is fully open. Turn the knob as far as it will go before removing the tensioner from the cable.

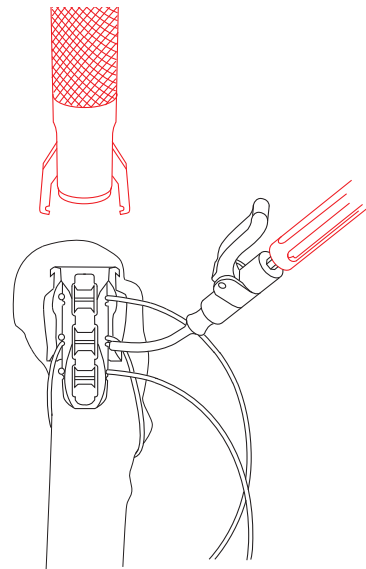

14

Pass and tension remaining cables

Pass remaining cables following steps 6 to 8 (pages 24–25).

Tension and lock them with the temporary tension holder following steps 9 to 13 (pages 26–28).

Alternative: Pass all three cables prior to tensioning.

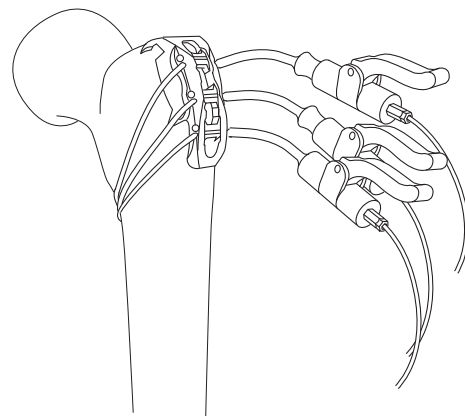

15

Check level of tension

Check that the desired level of tension has been applied to each cable. If necessary, further tensioning may be applied to each cable prior to final crimping.

Important: Repeated tensioning of the cable at high loads may cause fraying of the cable.

16

Crimp the cables

Instrument

391.882	Cable Crimper
---------	---------------

Place the jaws of the cable crimper over the center of the middle cable crimp, and squeeze the handles together. Use the starter handle to begin squeezing until the outer handle can be easily grasped.

The ratchet mechanism of the crimper controls the amount of deformation, thus preventing under- or overcrimping. The crimper will automatically release when the cable is crimped.

Crimp the other cables using the same procedure.

Note: Visually check that the cable crimp is centered and fully seated in the jaws of the crimper prior to crimping the cable. Improper placement may lead to cable slippage or crimp failure.

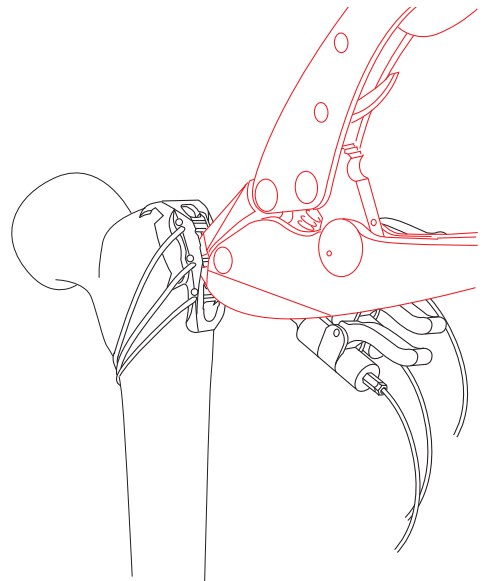

17**Remove temporary tension holders**

After crimping the cables, remove the temporary tension holders by pushing the lever forward to the “open” position.

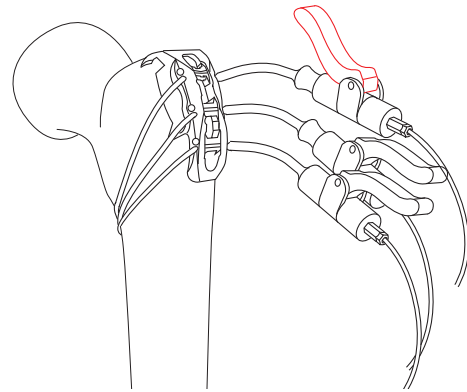
**18****Cut the cables****Instrument**

391.905	Cable Cutter, standard
or	
391.906	Cable Cutter, large

To cut the cables, pass the free end of the cable through the jaws of the cable cutter, and squeeze the handles together. Place the cable completely in the cutter jaws, but near the tip. Cut in one motion to ensure a clean cut. Cut the other cables using the same procedure.

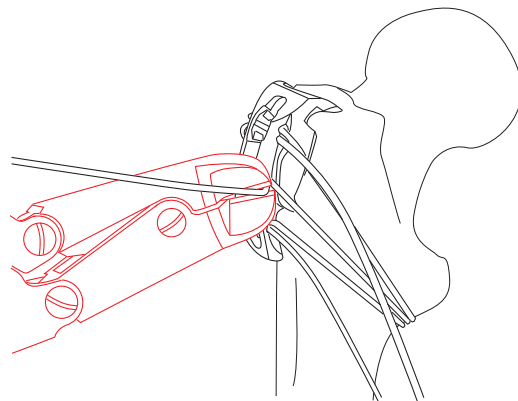
**Notes**

- Each cable should be cut as closely to the TRD as possible, taking care not to damage the adjacent cable.
- The TRD is also available in a large version. The operation steps are similar for the TRD. The large TRD is indicated when an additional femur neck fracture occurs.

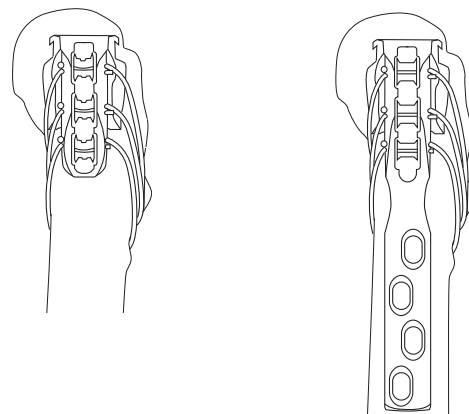

Cleaning Instruments

Instruments

391.201	Cable Tensioner
319.270	Cleaning Brush Ø 2.1 mm, for Cannulated Instruments
319.360	Cleaning Stylet Ø 2.0 mm, for Cannulated Instruments
519.970	Oil Dispenser

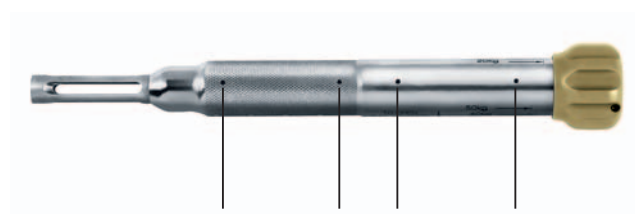















Lubricating holes

The Cable Tensioner must be cleaned and lubricated after each use.

- 1 Open the cannulation fully by turning the fluted knob counterclockwise until it stops.
- 2 Clean the tensioner manually under running water using a mild cleaning solution (neutral pH) and a soft brush. Do not submerge.
- 3 Use the 2.0 mm cleaning stylet and the 2.1 mm cleaning brush to remove any debris from the cannulation.
- 4 Flush the unit thoroughly with water.
- 5 Dry thoroughly with a soft cloth.
- 6 Apply 4–6 drops of autoclavable oil:
 - a into each of the lubricating holes in the tensioner.
 - b into the cannulation at the back end of the instrument while the tensioner is in a vertical position.
 - c into the cannulation of the nose piece while the tensioner is in a vertical position.
- 7 Spread the oil throughout the mechanism by rotating the fluted knob through several full turns.
- 8 Follow your institution's standard protocol for sterilization.

Note: Failure to clean and lubricate the tensioner after each use may result in poor performance and reduce the operating life of the instrument.

Implants

X98.838.01	Positioning Pin 3.5 with thread, for LCP		
X98.838.01S	Positioning Pin 3.5 with thread, for LCP, sterile		
X98.803.01	Positioning Pin 4.5 with thread, for LCP		
X98.803.01S	Positioning Pin 4.5 with thread, for LCP, sterile		
X98.837	Cerclage Positioning Pin for LCP 3.5 and LC-DCP 3.5		
X98.837S	Cerclage Positioning Pin for LCP 3.5 and LC-DCP 3.5, sterile		
X98.839	Cerclage Positioning Pin for LCP 4.5 and LC-DCP 4.5		
X98.839S	Cerclage Positioning Pin for LCP 4.5 and LC-DCP 4.5, sterile		
0X.221.002.05	Cerclage Eye for Screws Ø 3.5 mm, Stardrive and hexagonal socket, pack of 5 units		
0X.221.002S	Cerclage Eye for Screws Ø 3.5 mm, Stardrive and hexagonal socket, sterile		
0X.221.003.05	Cerclage Eye for Screws Ø 4.5 mm, Stardrive and hexagonal socket, pack of 5 units		
0X.221.003S	Cerclage Eye for Screws Ø 4.5 mm, Stardrive and hexagonal socket, sterile		
0X.221.004.05	Cerclage Eye for Hexagonal Socket Ø 4.0 mm, cannulated, pack of 5 units		
0X.221.004S	Cerclage Eye for Hexagonal Socket, Ø 4.0 mm, cannulated, Stainless Steel, sterile		

X98.800.01 Cerclage Cable with Crimp Ø 1.0 mm
X98.800.01S Cerclage Cable with Crimp Ø 1.0 mm,
sterile

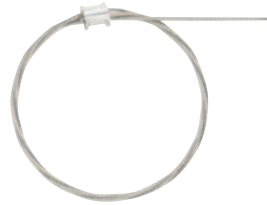

298.801.01 Cerclage Cable with Crimp Ø 1.7 mm,
Stainless Steel
298.801.01S Cerclage Cable with Crimp Ø 1.7 mm,
Stainless Steel, sterile



611.105.01 Cerclage Cable with Crimp, Ø 1.7 mm,
Cobalt-chrome alloy
611.105.01S Cerclage Cable with Crimp Ø 1.7 mm,
Cobalt-chrome alloy, sterile

498.806 TRD – Trochanter Reattachment Device,
small, for Cable System,
Titanium Alloy (TAN)
498.806S TRD – Trochanter Reattachment Device,
small, for Cable System,
Titanium Alloy (TAN), sterile

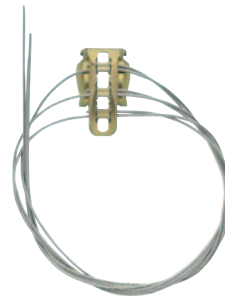

498.807 TRD – Trochanter Reattachment Device,
large, for Cable System,
Titanium Alloy (TAN)
498.807S TRD – Trochanter Reattachment Device,
large, for Cable System,
Titanium Alloy (TAN), sterile

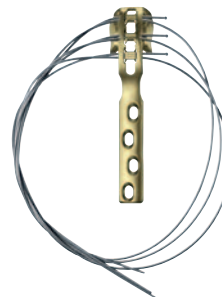

X=2: Stainless Steel
X=4: Titanium

Instruments

391.201 Cable Tensioner



391.883 Attachment Bit for Tension Holder



391.884 Tension Holder, for temporary use



391.882 Cable Crimper



391.885 Holding Forceps for Cerclage Eyes and Positioning Pin

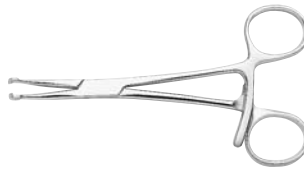

391.905 Cable Cutter, standard



391.906 Cable Cutter, large



391.103–108 Cable Passer, available in various designs and sizes



391.919 Impactor for TRD, for Cable System



Cable System in Vario Case

188.215 Cable System in Vario Case

Instruments

391.103	Cable Passer, medium, curved	1
391.104	Cable Passer, large, curved	1
391.105	Cable Passer, medium	1
391.106	Cable Passer, medium, 45° angle	1
391.107	Cable Passer, large	1
391.108	Cable Passer, large, 45° angle	1
391.201	Cable Tensioner	1
391.919	Impactor for TRD, for Cable System	1
391.882	Cable Crimper	1
391.883	Attachment Bit for Tension Holder	4
391.884	Tension Holder, for temporary use	4
391.885	Holding Forceps for Cerclage Eyes and Positioning Pin	1
391.905	Cable Cutter, standard	1
391.906	Cable Cutter, large	1
688.215	Vario Case for Cable System	1

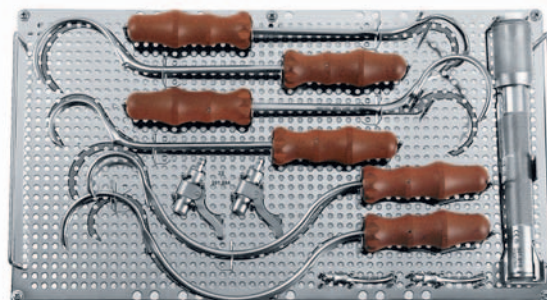
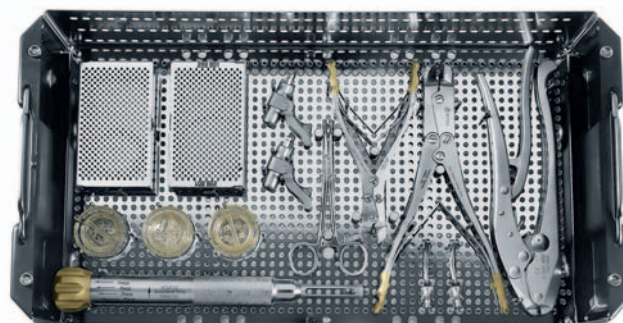

Implants

298.800.01	Cerclage Cable with Crimp Ø 1.0 mm, Stainless Steel	5
298.801.01	Cerclage Cable with Crimp Ø 1.7 mm, Stainless Steel	5
298.837	Cerclage Positioning Pin for LCP 3.5 and LC-DCP 3.5, Stainless Steel	5
298.839	Cerclage Positioning Pin for LCP 4.5 and LC-DCP 4.5, Stainless Steel	5
02.221.002.05	Cerclage Eye for Screws Ø 3.5 mm, Stardrive and hexagonal socket, Stainless Steel, pack of 5 units	5
02.221.003.05	Cerclage Eye for Screws Ø 4.5 mm, Stardrive and hexagonal socket, Stainless Steel, pack of 5 units	5
298.838.01	Positioning Pin 3.5 with thread, for LCP, Stainless Steel	5
298.803.01	Positioning Pin 4.5 with thread, for LCP, Stainless Steel	5



Synthes GmbH
Eimattstrasse 3
CH-4436 Oberdorf
www.synthes.com

All technique guides are available as PDF files at
www.synthes.com/lit



CE
0123