

PFNA. Proximal Femoral Nail Antirootation.

Technique Guide



This publication is not intended for
distribution in the USA.

Instruments and implants
approved by the AO Foundation.

 **SYNTHES**®

 Image intensifier control

Warning

This description alone does not provide sufficient background for direct use of the instrument set. Instruction by a surgeon experienced in handling these instruments is highly recommended.

Processing, Reprocessing, Care and Maintenance

For general guidelines, function control and dismantling of multi-part instruments, as well as processing guidelines for implants, please contact your local sales representative or refer to: www.synthes.com/reprocessing

For general information about reprocessing, care and maintenance of Synthes reusable devices, instrument trays and cases, as well as processing of Synthes non-sterile implants, please consult the Important Information leaflet (SE_023827) or refer to: www.synthes.com/reprocessing

Table of Contents

Introduction	PFNA. Proximal Femoral Nail Antirotation	2
	AO Principles	5
	Indications and Contraindications	6
	Clinical Cases	7
Surgical Technique	Preoperative Planning	8
	Patient Positioning	9
	Preparation	10
	Open Femur	14
	Insert Nail	17
	Proximal Locking	20
	Distal Locking	38
	– For PFNA Short	40
	– For PFNA Long	45
	Insert End Cap	48
	Implant Removal	50
	Correction of Insertion Depth of PFNA Blade	53
	Cleaning	54
Product Information	Implants	55
	Alternative Implants	62
	Instruments	65
	Cases	74
	Power Tools	78
	Optional: Angular Stable Locking System (ASLS)	79
Bibliography		81

PFNA. Proximal Femoral Nail Antirotation.

PFNA Nail Optimal fit

The anatomical design guarantees an optimal fit in the femur. The nail design has been well proven in over 450 000 cases performed with the PFN and PFNA.



The PFNA has a medial-lateral angle of 6°
This allows insertion at the tip of the greater trochanter.

Optimal stress distribution

The flexible PFNA tip eases insertion and reduces stress on the bone at the tip of the PFNA.

Several distal locking options

Static or dynamic locking can be performed via the aiming arm with PFNA standard, small and xs. The PFNA long additionally allows for secondary dynamization.

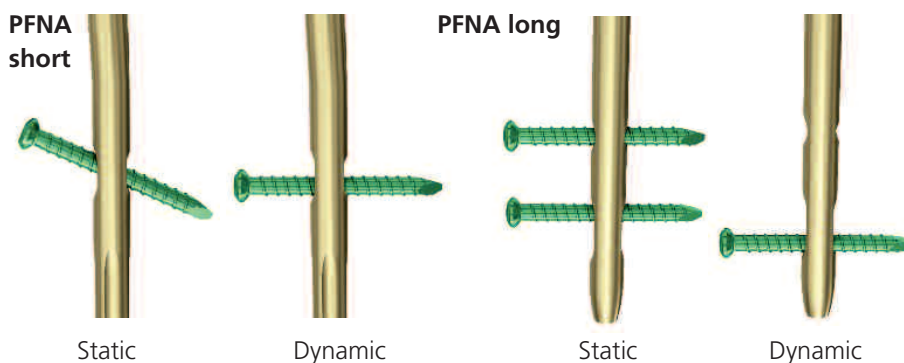

PFNA Nail Product range

The PFNA is available in 4 sizes



PFNA xs, length 170 mm

PFNA small, length 200 mm

PFNA, length 240 mm

PFNA long, length 300–420 mm,
with 20 mm increments, bending
radius 1500 mm

PFNA. Proximal Femoral Nail Antirotation.

PFNA Blade

Rotational and angular stability achieved with one single element

Compaction of cancellous bone

Inserting the PFNA blade compacts the cancellous bone providing additional anchoring, which is especially important in osteoporotic bone.

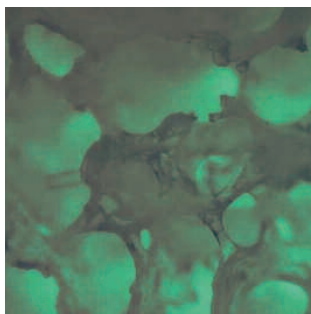

Bone structure before insertion of the PFNA blade.

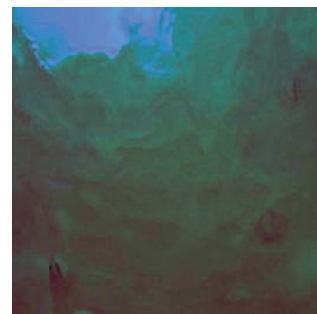

Bone structure after PFNA blade insertion – cancellous bone is compacted providing additional anchoring to the PFNA blade.

Large surface and increasing core diameter guarantee maximum compaction and optimal hold in bone

Increased stability caused by bone compaction around the PFNA blade has been biomechanically proven to retard rotation and varus collapse. Biomechanical tests have demonstrated that the PFNA blade had a significantly higher cut-out resistance in comparison with commonly-used screw systems.



Lateral locking – fast and reliable insertion of the PFNA blade

- All surgical steps required to insert the PFNA blade are performed through lateral incision
- The PFNA blade is automatically locked to prevent rotation of the blade and femoral head

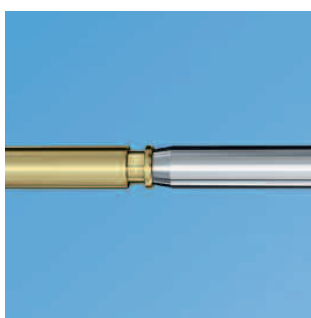

PFNA blade unlocked

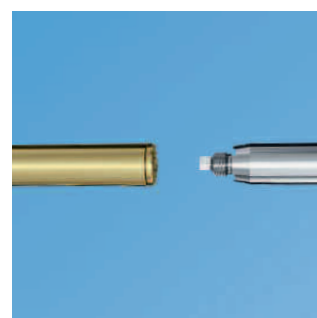

PFNA blade locked

In 1958, the AO formulated four basic principles^{1,2}, which have become the guidelines for internal fixation in general, and intramedullary nailing in particular:

Anatomic reduction

Before inserting the nail, the reduction can be achieved manually or using a reduction table. A guide wire marks the prescribed path into the medullary canal and secures alignment of the fragments while the cannulated nail is being inserted over the wire. The nail insertion is generally monitored using x-rays. The nail is then locked proximally and distally to the bone fragments in order to hold the reduction.

Stable fixation

The intramedullary nail acts as an internal splint that controls but does not prevent micromovements of the fragments. It provides a relative stability that leads to an indirect healing through callus formation. The nails are available in different diameters that allow the surgeon to optimize stability.

Preservation of blood supply

When the canal is not reamed, intramedullary nailing generates minimal trauma to the endosteum and, therefore, the blood supply is maximized through the uninjured endosteum and periosteum. Reaming the canal temporarily disrupts the endosteal blood supply but probably stimulates the revascularisation and therefore the bone healing.

Early, active mobilization

Intramedullary nailing, combined with the AO technique, provides relatively stable fracture fixation with minimal trauma to vascular supply. This helps to create an improved environment for bone healing, accelerating the patient's return to previous mobility and function.

¹ Müller ME, Allgöwer M, Schneider R, Willenegger H (1995) Manual of Internal Fixation. 3rd, expanded and completely revised ed. 1991. Berlin, Heidelberg, New York: Springer

² Rüedi TP, Buckley RE, Moran CG (2007) AO Principles of Fracture Management. 2nd expanded ed. 2002. Stuttgart, New York: Thieme

Indications and Contraindications

PFNA short (Length 170 mm–240 mm)

Indications

- Pertrochanteric fractures (31-A1 and 31-A2)
- Intertrochanteric fractures (31-A3)
- High subtrochanteric fractures (32-A1)

Contraindications

- Low subtrochanteric fractures
- Femoral shaft fractures
- Isolated or combined medial femoral neck fractures



PFNA long (Length 300 mm–420 mm)

Indications

- Low and extended subtrochanteric fractures
- Ipsilateral trochanteric fractures
- Combination fractures (in the proximal femur)
- Pathological fractures

Contraindications

- Isolated or combined medial femoral neck fractures

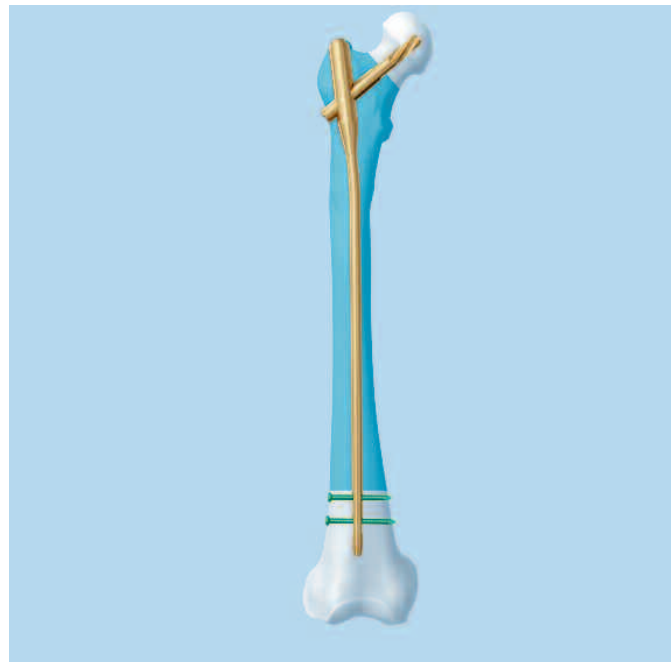

Note: ASLS, the Angular Stable Locking System, is indicated in cases where increased stability is needed in fractures closer to the metaphyseal area or in poor quality bone. For more details regarding the intramedullary fixator principle, please consult the ASLS technique guide (036.000.708) and concept flyer (036.001.017).

Clinical Cases



94 years, female 31-A1.1



0 days post-op



14 weeks post-op



11 months post-op



93 years, female, 31-A3.3



4 days post-op



4 weeks post-op



5 months post-op

Preoperative Planning

Use the preoperative planner template for the PFNA to estimate the CCD angle, nail diameter and length.

- Take a preoperative AP radiography of the unaffected leg. Determine the CCD angle using a goniometer or the preoperative planning template.

To estimate the CCD angle, place the template on the AP x-ray of the uninjured femur and determine the CCD angle.

To estimate the nail diameter, place the template on the AP x-ray of the uninjured femur and measure the diameter of the medullary canal at the narrowest part that will contain the nail.

To estimate the nail length, place the template on the AP x-ray of the uninjured femur and select the appropriate nail length based on patient anatomy.

Note: When selecting the nail size, consider canal diameter, fracture pattern, patient anatomy and post-operative protocol.

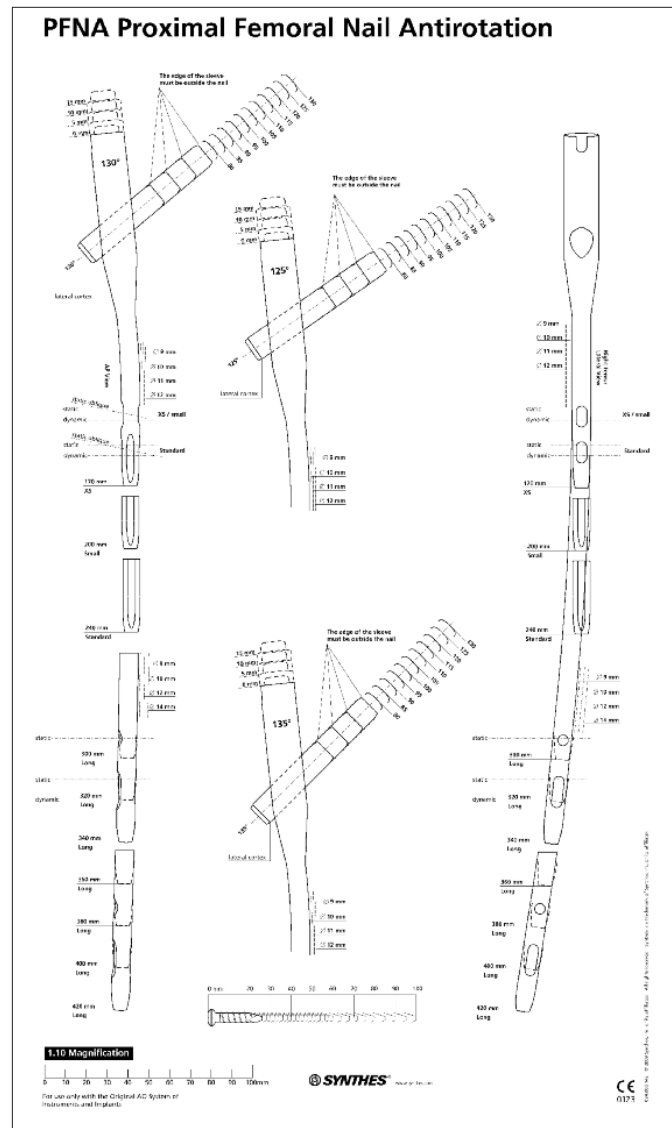

Patient Positioning

Position the patient supine on an extension table or a radiolucent operating table. Abduct the unaffected leg as far as possible and place it on a leg support, so that it allows free fluoroscopic examinations. This should be tested preoperatively.

For unimpeded access to the medullary cavity, abduct the upper body by about 10–15° to the unaffected side (or adduct the affected leg by 10–15°).

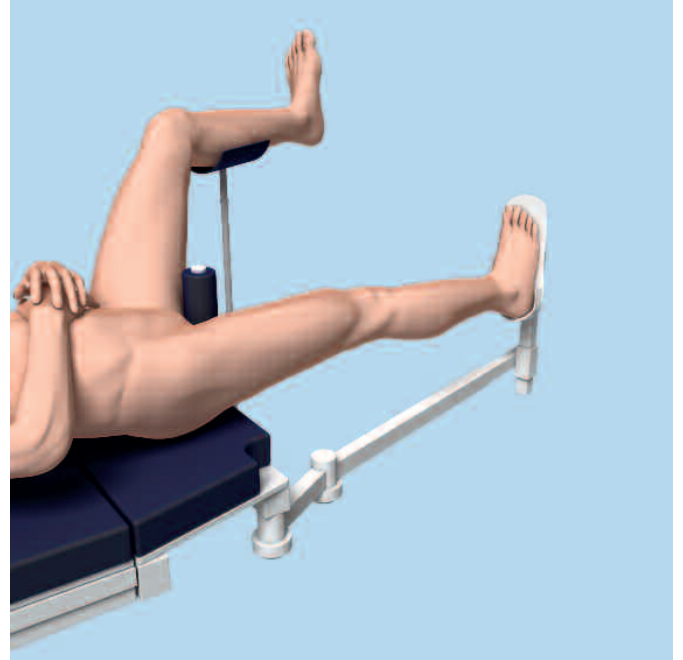

1

Reduce fracture

- ⌚ Perform closed reduction of the fracture under image intensifier control. If the result is not satisfactory, perform open reduction.

Note: Exact anatomical reduction and secure fixation of the patient to the operating table are essential for easy handling and a good surgical result.

2

Confirm nail length and diameter

Instrument

309.602 Radiographic Ruler for PFNA

The required nail length must be determined after reduction of the femoral fracture.

- 1 Position the C-arm for an AP view of the proximal femur. With long forceps, hold the ruler alongside the lateral thigh, parallel to and at the same level as the femur. Adjust the ruler until the proximal end is at the desired nail insertion position. Mark the skin at the proximal end of the ruler.
- 2 Move the C-arm distally. Align the proximal end of the radiographic ruler to the skin mark, and take an AP image of the distal part. Verify fracture reduction going from proximal to the fracture to distal.

Read the nail length directly from the ruler image. For long nails, select the measurement at or just proximal to the epiphyseal scar, or at the chosen insertion position.

Important

- It is recommended that all fractures are treated with the longest nail possible, taking into account patient anatomy or a previous implant.
 - Standard PFNA (length 240 mm) may be too long for small stature people.
 - For fractures extending below the lesser trochanter always use a long nail.
-

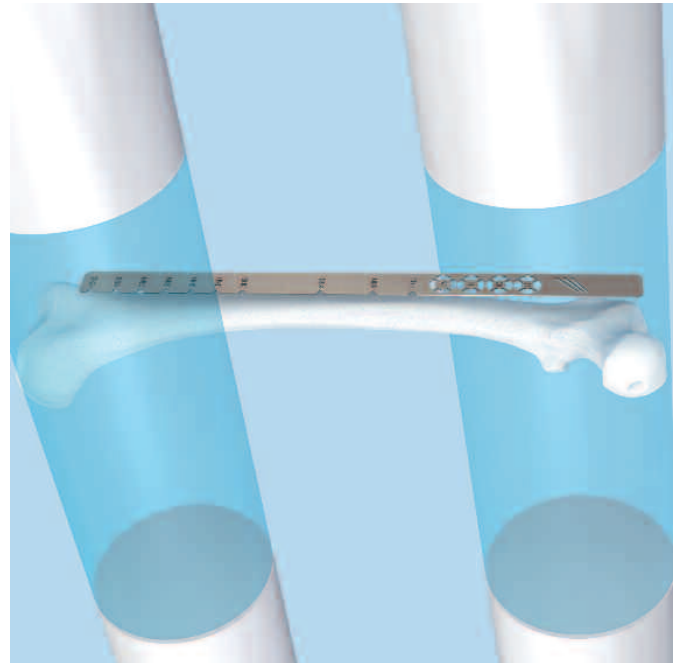

Alternatives

Determine the nail length by the procedure above on the uninjured leg before draping (unsterile) or compare the length of two identical SynReam reaming rods \varnothing 2.5 mm (352.032) or use the depth gauge (351.717 and 351.719) in combination with the SynReam reaming rod \varnothing 2.5 mm, length 950 mm (352.032).

Place the radiographic canal width estimator perpendicular to the femur axis so that the diameter gauge is located over the isthmus. Select the nail diameter with which the intramedullary canal-to-cortex transition is still visible on both sides of the diameter gauge.

Notes

- The ruler provides only an estimate of the canal diameter as it is not at the same level as the femur.
 - If the reamed technique is used, the diameter of the largest medullary reamer applied must be 0.5 mm to 1.5 mm larger than the nail diameter.
 - Always choose the largest diameter nail that fits into the intramedullary canal (\varnothing 9 mm nails should only be used for an intramedullary canal smaller than 11 mm).
-

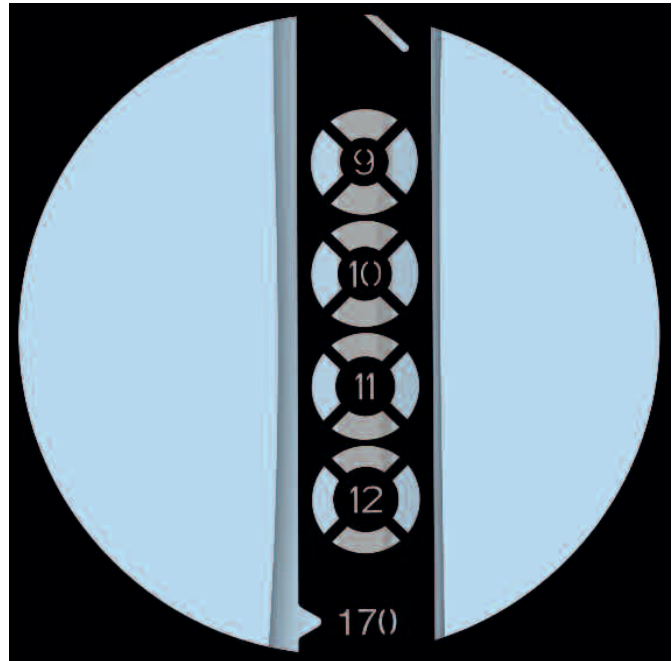

3

Approach

Palpate the trochanter major.

Make a 5 cm incision proximal from the tip of the greater trochanter. Make a parallel incision of the fasciae of the gluteus medius and split the gluteus medius in line with the fibers.

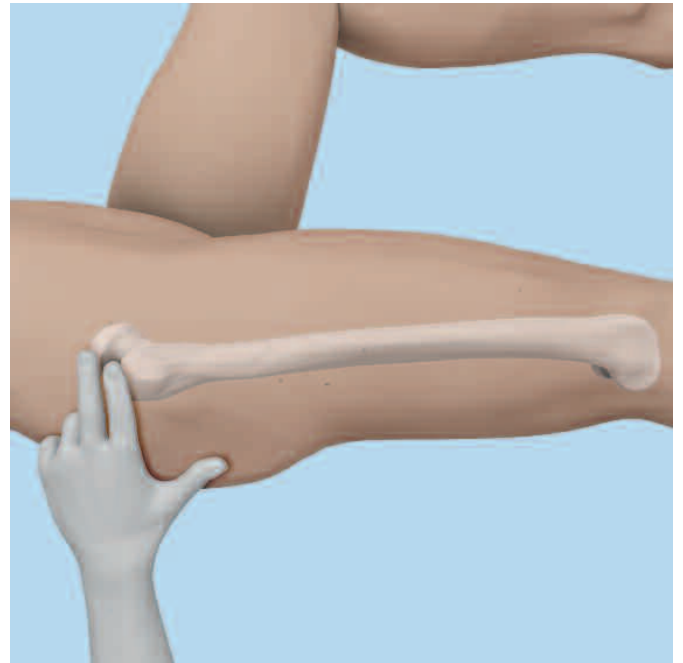

Open Femur

1

Determine entry point

- 1 In AP view, the PFNA entry point is on the tip or slightly lateral to the tip of the greater trochanter in the curved extension of the medullary cavity, as the ML angle of the PFNA is 6°.
- 2 In lateral view the entry point is in line with the axis of the intramedullary canal.

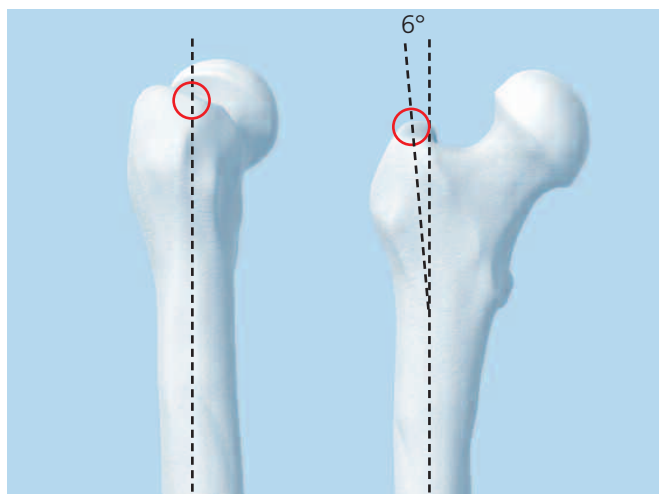

2

Insert guide wire

Instruments

356.830	Guide Wire Ø 3.2 mm, for PFNA Blade
393.100	Universal Chuck with T-Handle
357.001	Protection Sleeve 20.0/17.0, for No. 357.005
309.603	Drill Sleeve 17.0/3.2, for No. 357.001

Secure the guide wire in the power tool. Alternatively, the universal chuck with T-handle can be used to insert the guide wire manually.

Position both the protection sleeve and the drill sleeve at the insertion point. Insert the guide wire through the protection sleeve and the drill sleeve. Remove the power tool and the drill sleeve.

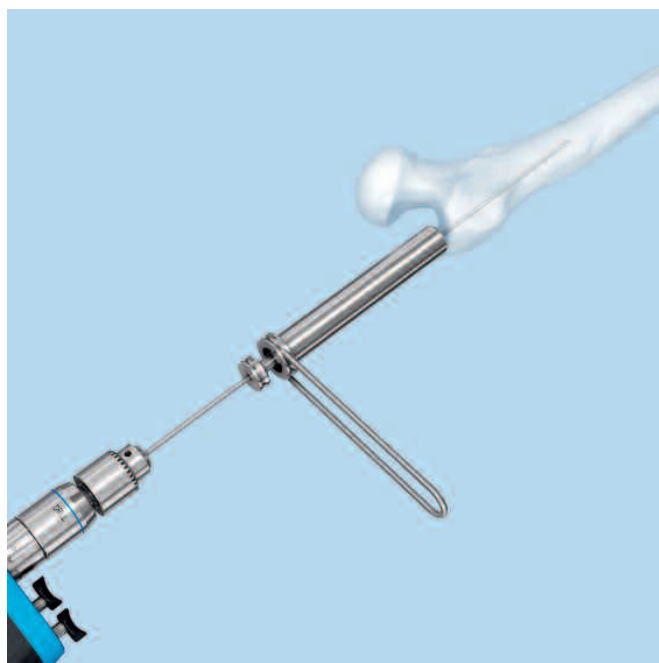

Note: The correct entry point and angle are essential for a successful result. To ensure the correct position of the guide wire, position a guide wire ventrally on the femur and check under image intensifier control.

- 1

3

Open femur

Instruments

309.600	Drill Bit Ø 17.0 mm, cannulated, for PFNA
357.001	Protection Sleeve 20.0/17.0, for No. 357.005
393.100	Universal Chuck with T-Handle

Guide the cannulated drill bit through the protection sleeve over the guide wire and drill as far as the stop on the protection sleeve. Remove the drill bit, the protection sleeve and the guide wire.

Note: It is recommended to open the femur by using a power tool at high speed or carefully by hand. To prevent dislocating the fracture fragments, avoid lateral movements or excessive compression forces.



4

Option: Ream medullary canal

Instruments

189.060/ 175.500	SynReam Intramedullary Reaming System
351.782	Holding Forceps for Reaming Rods

If necessary, enlarge the femoral canal to the desired diameter using the medullary reamer and the corresponding technique guide (036.000.808).

- Check fracture reduction under image intensifier control.

Insert reaming rod

Insert the reaming rod into the medullary canal to the desired insertion depth. The tip must be correctly positioned in the medullary canal since it determines the final distal position of the long PFNA.

Reaming

Starting with the 8.5 mm diameter reaming head, ream to a diameter of 0.5 to 1.5 mm greater than the nail diameter. Ream in 0.5 mm increments and advance the reamer with steady, moderate pressure. Do not force the reamer. Partially retract the reamer repeatedly to clear debris from the medullary canal.

Use the holding forceps to retain the reaming rod while reaming and to prevent it from rotating.



Insert Nail

1

Assemble PFNA instruments

Instruments

03.010.405	Insertion Handle, radiolucent, for PFNA
357.029	Connecting Screw, cannulated, for PFN
03.023.011	Screwdriver, hexagonal with spherical head \varnothing 10.0 mm

Guide the connecting screw through the insertion handle and secure the desired PFNA to the insertion handle using the hexagonal screwdriver with spherical head.

Important: Ensure that the connection between PFNA and insertion handle is tight (retighten, if necessary) to avoid deviations when inserting the PFNA blade through the aiming arm. Do not attach the aiming arm yet.



2

Insert PFNA

- Use image intensifier control to insert the PFNA.

Carefully insert the PFNA manually using slight bidirectional turns of the insertion handle as far as possible into the femoral opening. If the PFNA cannot be inserted, select a smaller size PFNA diameter or ream the medullary cavity to a diameter that is at least 1 mm larger than that of the selected nail.

The correct PFNA insertion depth is reached as soon as the projected PFNA blade is positioned in the center of the femoral head. A too cranial or too caudal PFNA position should be avoided as it can lead to malposition of the PFNA blade.

The anteversion can be determined by inserting a guide wire ventral to the femoral neck in the femoral head. In the mediolateral view, place the insertion handle parallel to the guide wire to align the correct rotation of the PFNA.

Remove all guide wires. Do not reuse. Dispose of the guide wires.

Important: Always ensure that the PFNA is firmly attached to the insertion handle.

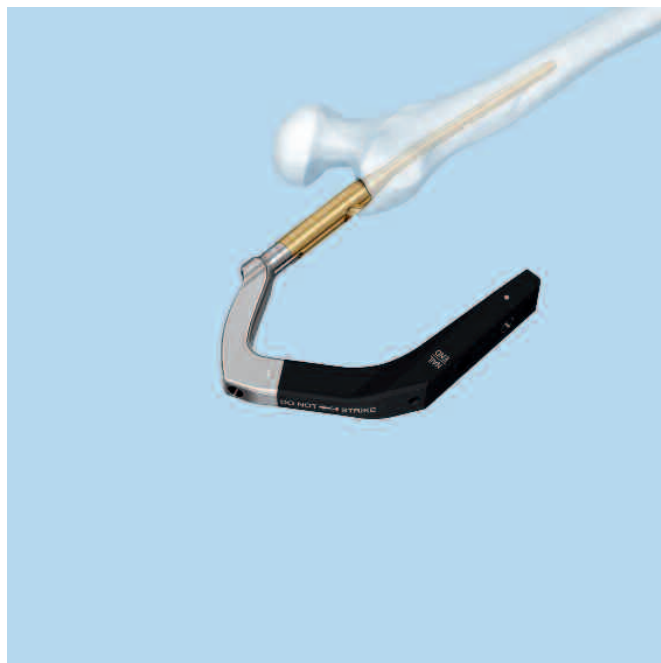

Optional instruments

03.010.424 Connector for Insertion Handle for PFNA

03.010.124 Combined Hammer 500 g, can be mounted, for No. 357.117

357.071 Hammer Guide, for No. 357.026

Attach the connector on the insertion handle and use light hammer blows on the connector to insert the nail.

Remove the connector.

Optionally, instead of the connector, the hammer guide can be threaded into the insertion handle and the hammer can be used as a slide hammer.

Remove the hammer guide.

Important: Use only light blows on the connector for insertion handle. Avoid unnecessary use of force to prevent loss of reduction or an iatrogenic fracture.



Proximal Locking

1

Choose aiming arm for PFNA blade insertion

Instruments

03.010.406	Aiming Arm 125°, for PFNA Blade
03.010.407	Aiming Arm 130°, for PFNA Blade
03.010.408	Aiming Arm 135°, for PFNA Blade
03.010.470	Plug for Aiming Arm

Using the hexagonal screwdriver with spherical head, confirm that the connecting screw between the insertion handle and the PFNA is sufficiently tightened.

Mount the appropriate aiming arm based on the chosen CCD angle of the PFNA and fix it firmly to the insertion handle.

Insert the plug for aiming arm into the locking hole of the nail length that is NOT used in this case.



2

Prepare guide wire insertion

Instruments

356.817	Buttress/Compression Nut, for PFNA Blade
356.818	Protection Sleeve 16.0/11.0, for PFNA Blade
356.819	Drill Sleeve 11.0/3.2, for PFNA Blade
356.820	Trocar Ø 3.2 mm, for PFNA Blade, gold

Screw the buttress nut on the golden protection sleeve for PFNA blade. Make sure the «lateral side» marking points towards the head of the sleeve. Screw the buttress nut up to the marking on the protection sleeve.

Insert the golden drill sleeve and the golden trocar through the protection sleeve.

Advance the entire sleeve assembly for PFNA blade through the aiming arm to the skin until it clicks into the aiming arm. Adjust the position of the buttress nut if necessary.

Important: Ensure that the sleeve assembly clicks into the aiming arm, otherwise it will not guarantee the exact position of the PFNA blade.

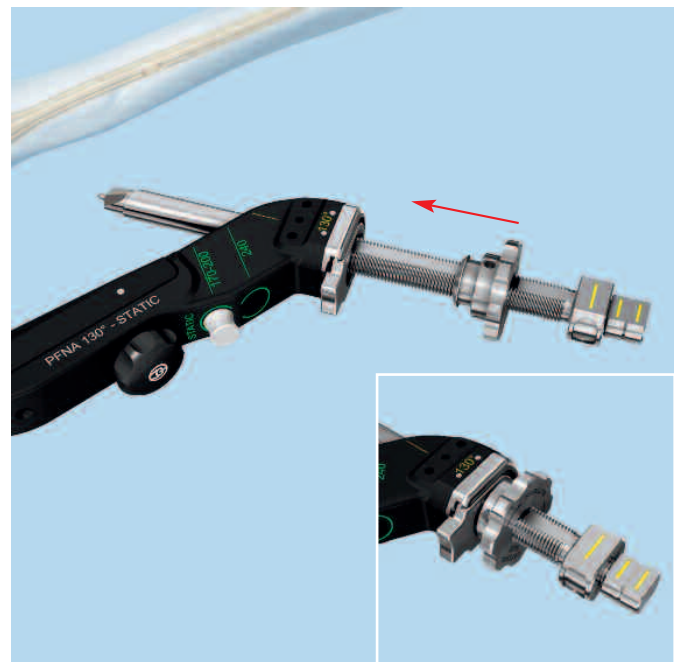

3

Option: Position guide wire with aiming device

Instruments

03.010.412	Aiming Device for Guide Wire, for PFNA and TFN, for AP Orientation
03.010.414	Connecting Screw for PFNA, for No. 03.010.412

Attach the guide wire aiming device for AP orientation to the aiming arm using the connecting screw for PFNA.

- ① Position the C-arm for the AP view. Rotate the C-Arm until any two orientation lines are symmetric to the protection sleeve.

The midline in between these two orientation lines predicts the location of the guide wire and PFNA Blade.

Adapt the insertion depth of the nail until the midline is centered in the femoral head.

The C-arm may be readjusted to make sure that two lines are symmetric to the sleeve.

Note: The outer lines can be used to determine the center of the femoral head.

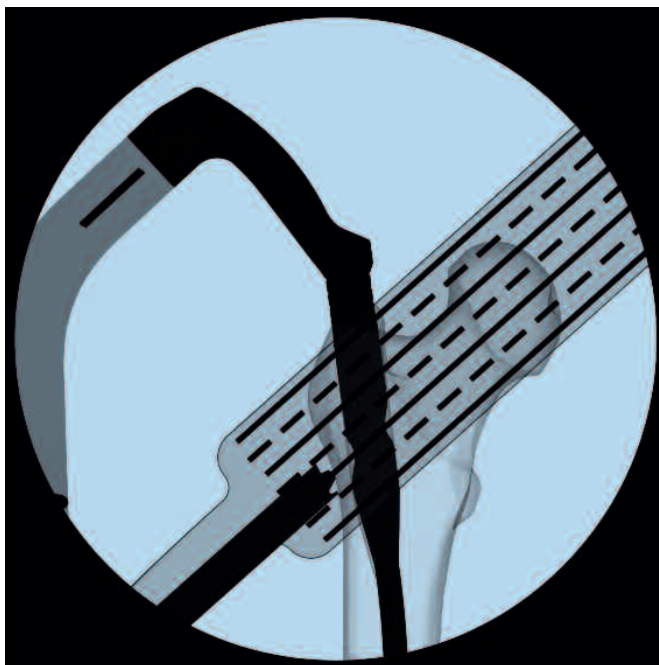

- ① Position the C-arm in the true lateral view (alignment of the axis of the femoral neck congruent with the axis of the femoral shaft¹).

Adjust nail rotation until the two lines on the insertion handle are symmetric to the PFNA nail.

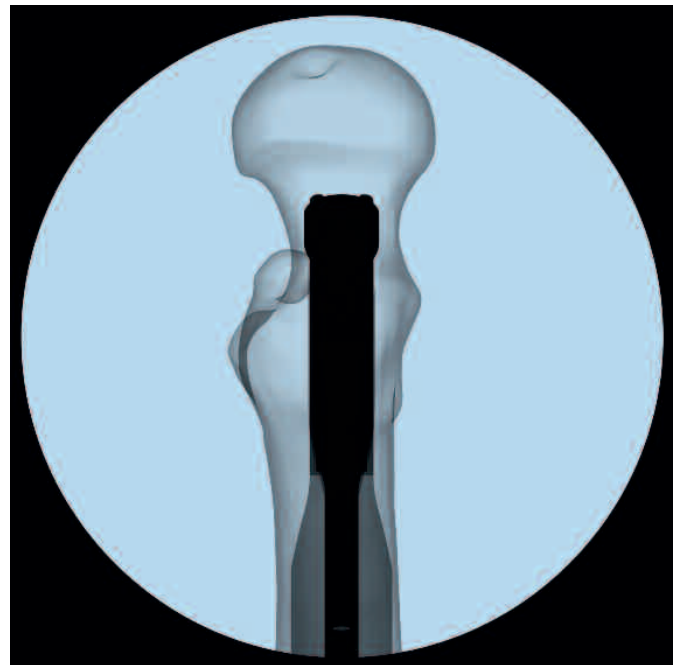

¹T. Nishiura, 1077-1083

4

Insert guide wire

Instrument

356.830 Guide Wire Ø 3.2 mm, for PFNA Blade

Make a stab incision in the area of the trocar tip. Advance the sleeve assembly through the soft tissues in direction of the lateral cortex.

Insert the sleeve assembly as far as the lateral cortex. Advance the protection sleeve to the lateral cortex using slight clockwise turns of the buttress nut. Prepare the passage of the protection sleeve by turning the internal golden drill sleeve.

Important: The sleeve assembly must be in contact with the bone during the entire blade implantation. Do not tighten the buttress nut too firmly as this could impair the precision of the insertion handle and sleeve assembly.

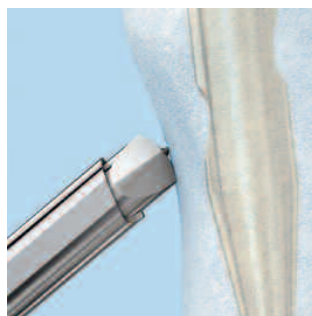
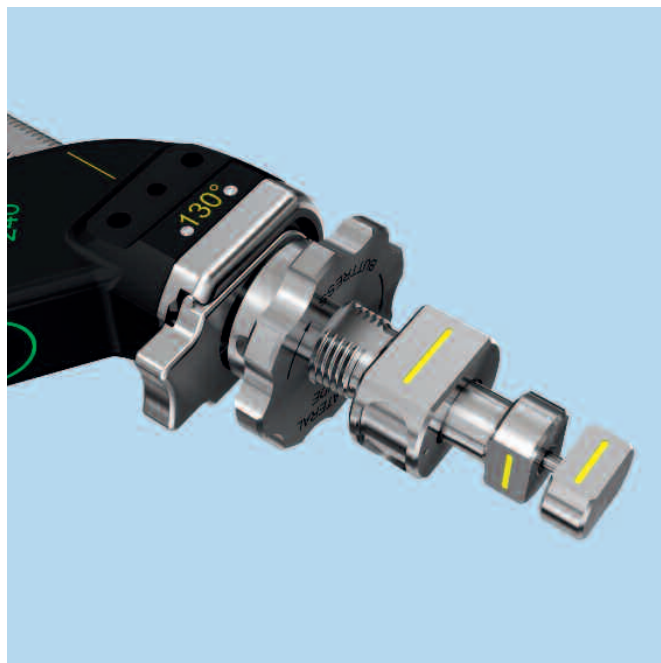

Incorrect position



Correct position

Remove the trocar. Insert a new guide wire through the golden drill sleeve into the bone. Verify both direction and position under image intensifier control in both AP and lateral view.



- ① In the AP and lateral view, the optimal position of the guide wire is the exact center of the femoral head. Insert the guide wire subchondrally into the femoral head at a distance of 10 mm below the joint level. Minimal distance to the joint is 5 mm. The tip of the guide wire is positioned at the intended blade tip position.

Important: If the PFNA or the guide wire requires repositioning; remove the guide wire, release the sleeve assembly with buttress nut from the aiming arm by pressing the button on the clamp device, and remove it. The PFNA can be repositioned only by rotation, deeper insertion or partial retraction. Reinsert the sleeve assembly and turn the buttress nut clockwise to position the assembly on the bone. Reinsert the guide wire.

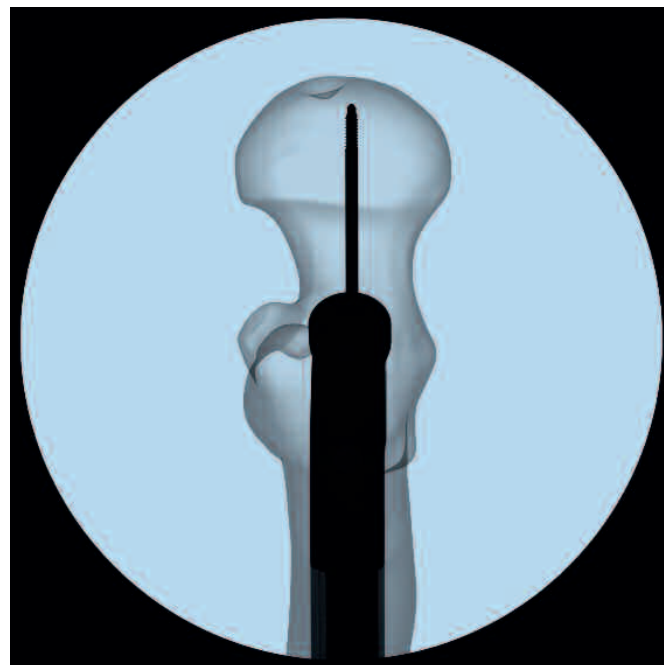
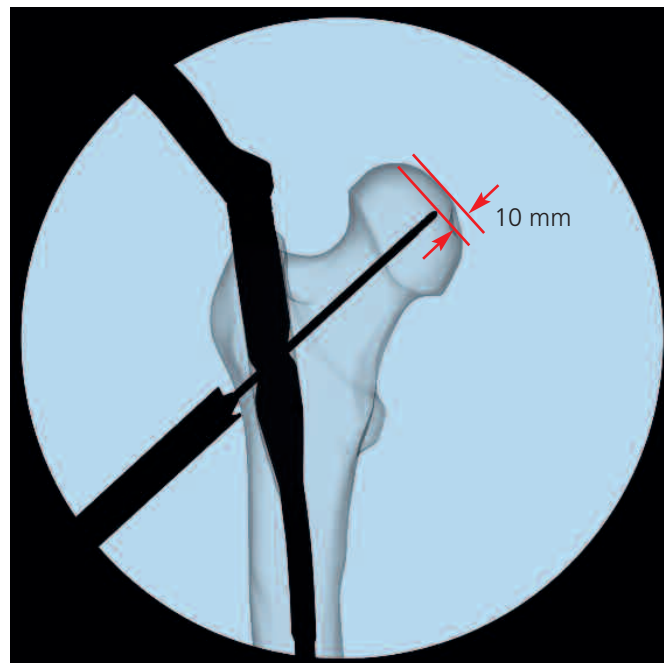

Optional technique for antirotation wires

Instruments

356.826	Aiming Jig for Anti-rotation Wire
356.827	Drill Sleeve 5.6/3.2, for No. 356.826
356.830	Guide Wire Ø 3.2 mm, for PFNA Blade

In very unstable fractures, insert an additional guide wire to prevent rotation. Leave the golden drill sleeve in place in the golden protection sleeve when applying this technique.

After having inserted the guide wire into the femoral head, secure the aiming jig for antirotation wire either anterior or posterior to the aiming arm. Secure the position of the antirotation wire by tightening the hexagonal nut.

Insert the drill sleeve into the aiming jig for antirotation wire. Make a stab incision and insert the drill sleeve to the bone.

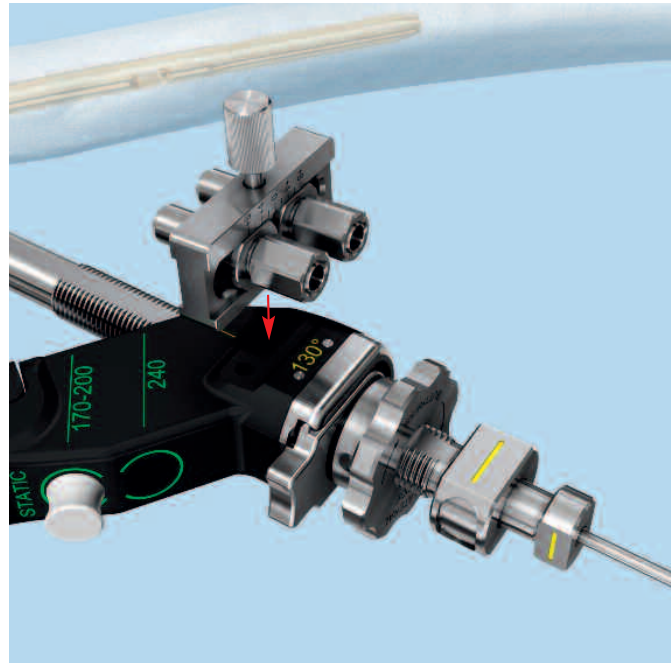

-
- ① Use image intensifier control to insert a guide wire into the femoral head. If a second anti-rotation wire is necessary, use the same procedure to insert it into the femoral head.
-

Note: In axial view, the antirotation wire will approach, but not touch the blade tip. This antirotation wire fixes the femoral head only temporarily and will be removed after the insertion of the blade.

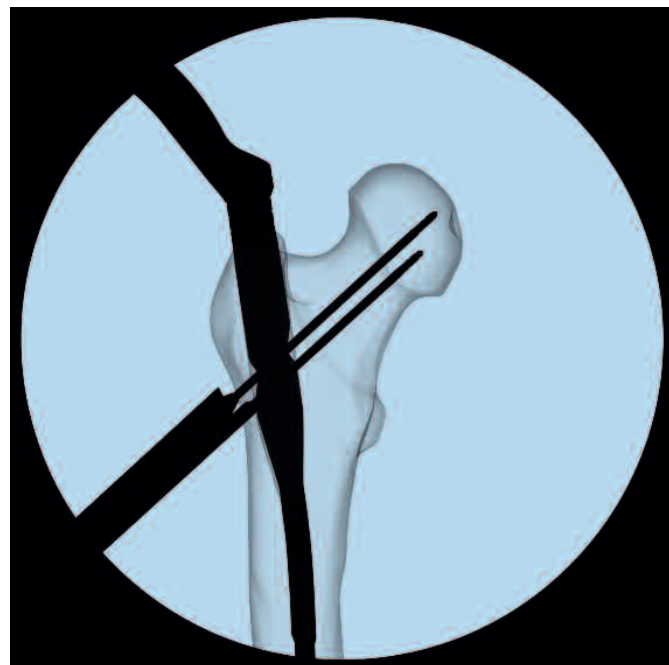

5

Measure the PFNA blade length

Instrument

356.829	Direct Measuring Device for Guide Wire Ø 3.2 mm
---------	--

- Verify the position of the guide wire in AP and lateral view before measuring the length.

Guide the measuring device over the guide wire. Advance the measuring device to the protection sleeve and determine the length of the required blade. The measuring device indicates the exact length of the guide wire in the bone.

In the AP and lateral view, the correct position of the PFNA blade is 10 mm below the joint level. Minimal distance to the joint is 5 mm. If the guide wire's position is subchondral, subtract 10 mm to measure the PFNA blade length correctly.

Remove the measuring device.

Carefully remove the golden drill sleeve without changing the position of the guide wire.

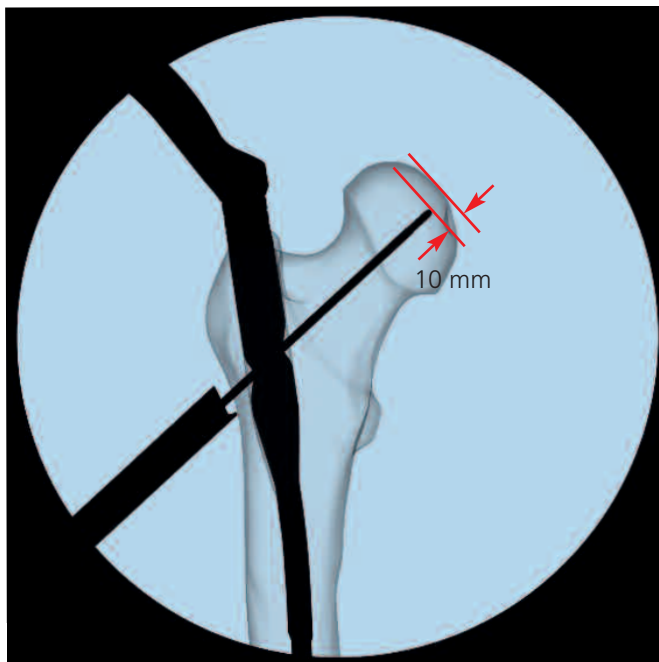

6

Open lateral cortex for PFNA blade insertion

Instrument

356.822 Drill Bit Ø 11.0 mm, for PFNA Blade

Push the cannulated drill bit over the 3.2 mm guide wire.
Drill to the stop. This opens the lateral cortex.

Important: If the guide wire has been bent slightly during insertion, guide the drill bit over the wire using carefully forward and backward movements. However, if the wire has been bent to a greater extent, reinsert it or replace it by a new guide wire (see step 4). Otherwise, the guide wire may be advanced through the joint.



7

Drill hole for PFNA blade

Instruments

356.821	Reamer \varnothing 11.0 mm, for PFNA Blade
357.046	Fixation Sleeve, for No. 357.045

Important: Use reamer only in a situation with good bone quality.

Set the chosen blade length on the cannulated reamer by fixing the fixation sleeve in the corresponding position. Read off the correct length on the side of the fixation sleeve pointing towards the tip of the reamer.

- Push the reamer over the guide wire. Monitor drilling under image intensifier control. Drill to the stop. The fixation sleeve prevents further drilling.

Note: Use the reamer only after opening the lateral cortex. If the guide wire has been bent slightly during insertion, guide the reamer over the wire using carefully forward and backward movements. However, if the wire has been bent to a greater extent, reinsert it or replace it with a new guide wire (see step 4). Otherwise, the guide wire may be advanced through the joint.

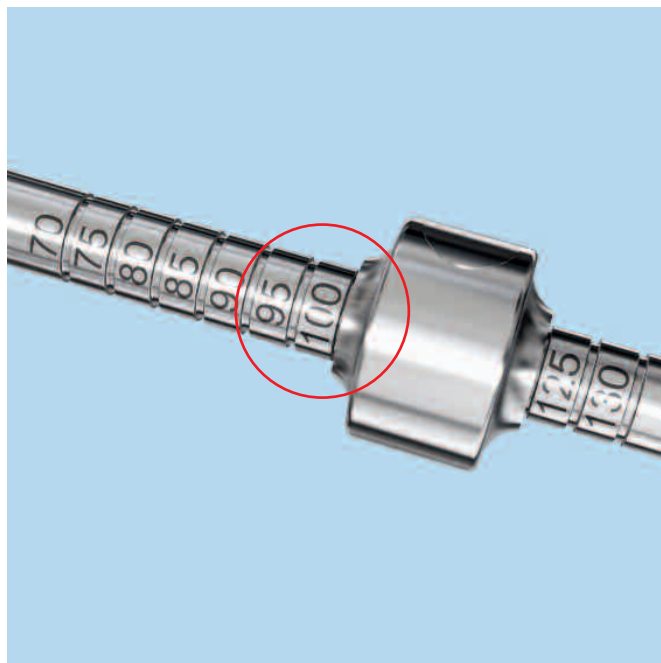

8

Assemble PFNA blade on the impactor

Instrument

03.010.410	Impactor for PFNA Blade
------------	-------------------------

The PFNA blade is supplied in a locked state.

While attaching the PFNA blade on the impactor, screw the impactor counterclockwise (note the mark "attach" on the impactor) into the end of the PFNA blade to unlock the blade. Push the PFNA blade gently towards the impactor while attaching the PFNA blade. Do not overtighten.

Important: The tip of the PFNA blade must rotate freely after attaching it to the impactor. This is essential for the implantation of the PFNA blade. Otherwise remove and dispose of the blade. Do not over tighten the connection between the impactor and the PFNA blade.

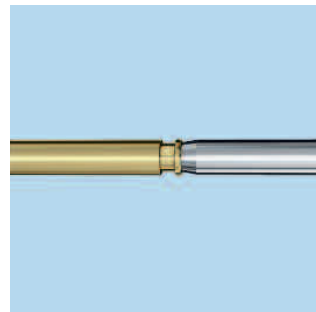
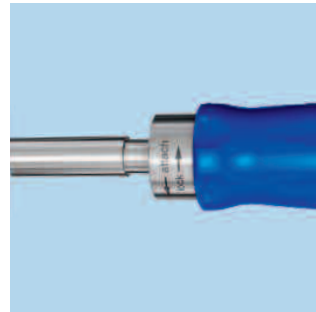
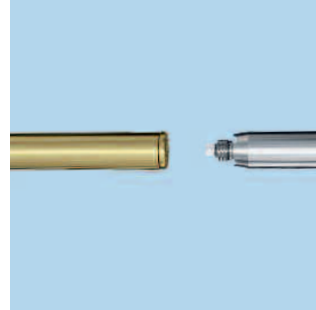

9

Insert PFNA blade

Instrument

03.010.124	Combined Hammer 500 g, can be mounted, for No. 357.117
------------	---

Insert the blade-impactor assembly over the guide wire. Push the button on the protection sleeve, align the blade (note marking on the protection sleeve) and advance the blade impactor assembly further through the protection sleeve.

Manually insert the blade over the guide wire advancing as far as possible into the femoral head.

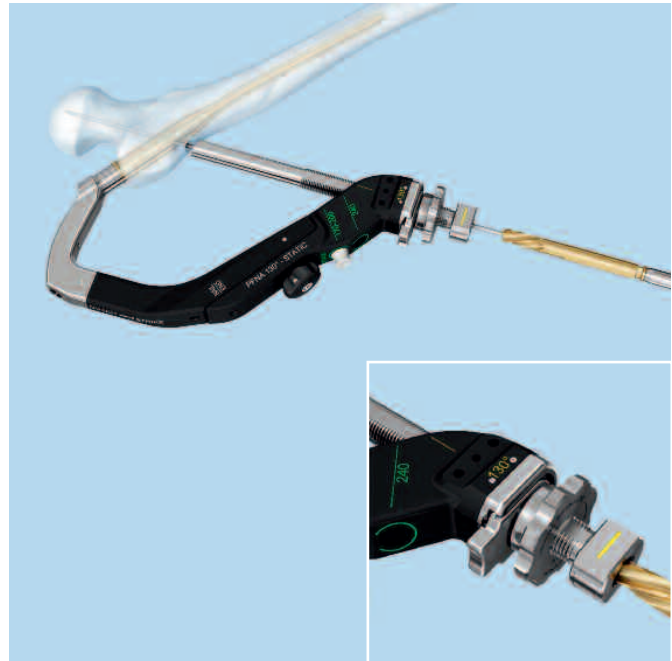

-
- ① Use monitoring during insertion of the PFNA blade.

Insert the PFNA blade to the stop by applying gentle blows with the hammer.

Important: Inserting the blade to the stop is important, as the impactor must click into the protection sleeve. Do not use unnecessary force when inserting the PFNA blade.



10

Lock PFNA blade

To lock the PFNA blade, turn the impactor clockwise (note «lock» marking on the handle) and tighten the blade.

Verify PFNA blade locking intraoperatively. The PFNA blade is locked if all gaps are closed.

Important: The gliding of the PFNA blade is guaranteed. If the PFNA blade cannot be locked, remove it and replace it with a new PFNA blade (see implant removal, step 1).

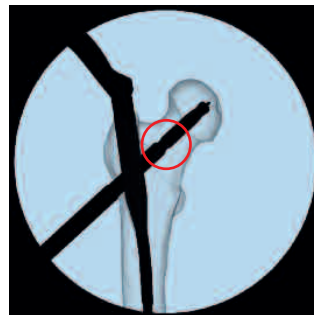
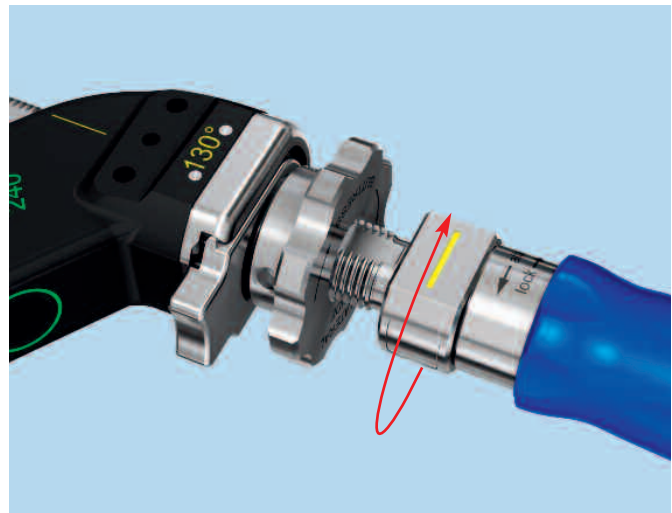

PFNA blade unlocked

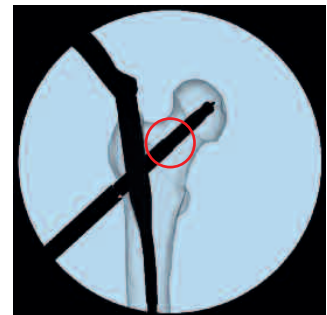

PFNA blade locked

Press the button on the protection sleeve to remove the impactor. Remove and dispose of the guide wire.

When proximal locking is complete, release and remove the protection sleeve and the buttress nut by pressing the button on the clamp device of the aiming arm in order to continue with distal locking or leave it in place to continue with intra-operative compression.

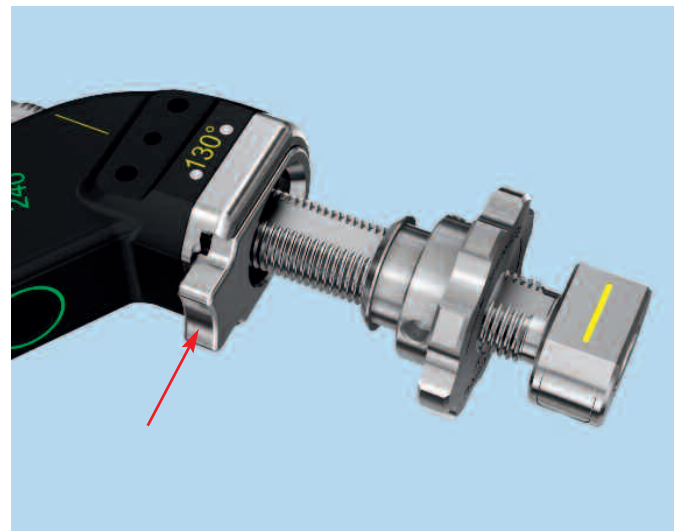
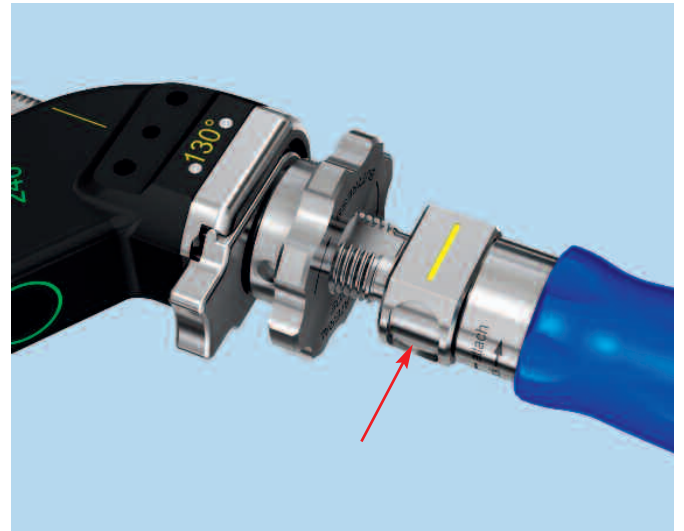

11

Option: Intraoperative compression

Instrument

03.010.423 Compression Instrument for PFNA Blade

Warning: Do not use intraoperative compression in osteoporotic bone.

Screw the compression instrument into the blade through the protection sleeve.

Turn the buttress nut counterclockwise to move the protection sleeve backwards until it is pushing towards the compression instrument.

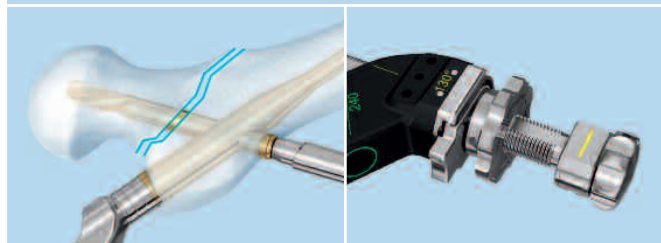
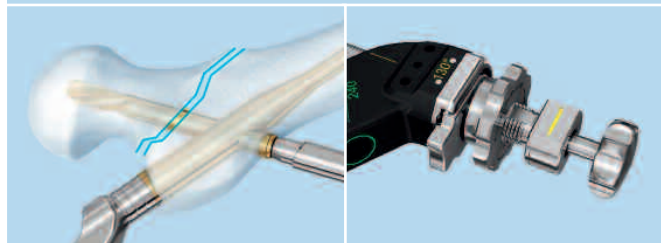
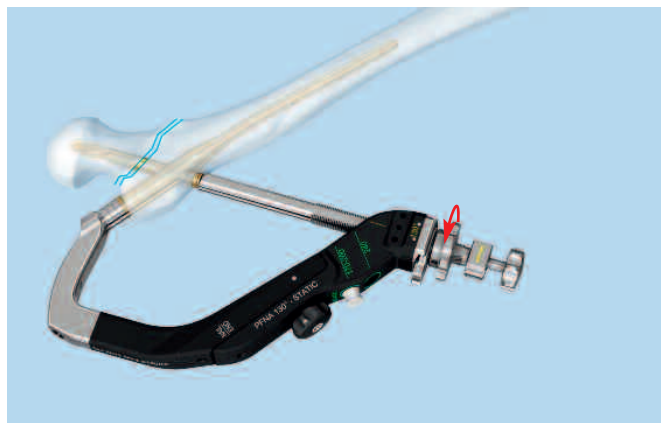

- ① Under image intensifier control, further turn the buttress nut counterclockwise to achieve intraoperative compression and close the fracture gap.

Important

- The blade must be locked to apply intraoperative compression.
- ① – Control compression under image intensifier control.
- Do not use excessive force in order to avoid pulling out the blade from the femoral head.

Note: The blade may be slightly overinserted before applying intraoperative compression (see correction of insertion depth of PFNA blade, page 51) to prevent it from sticking out laterally.

Release strain by turning the buttress nut clockwise.

- ① Remove the compression instrument. Verify PFNA blade locking under image intensifier control. The PFNA blade is locked if all gaps are closed. If necessary, relock the blade using the extraction screw.

Release and remove the protection sleeve and the buttress nut by pressing the button on the clamp device of the aiming arm to continue with distal locking.

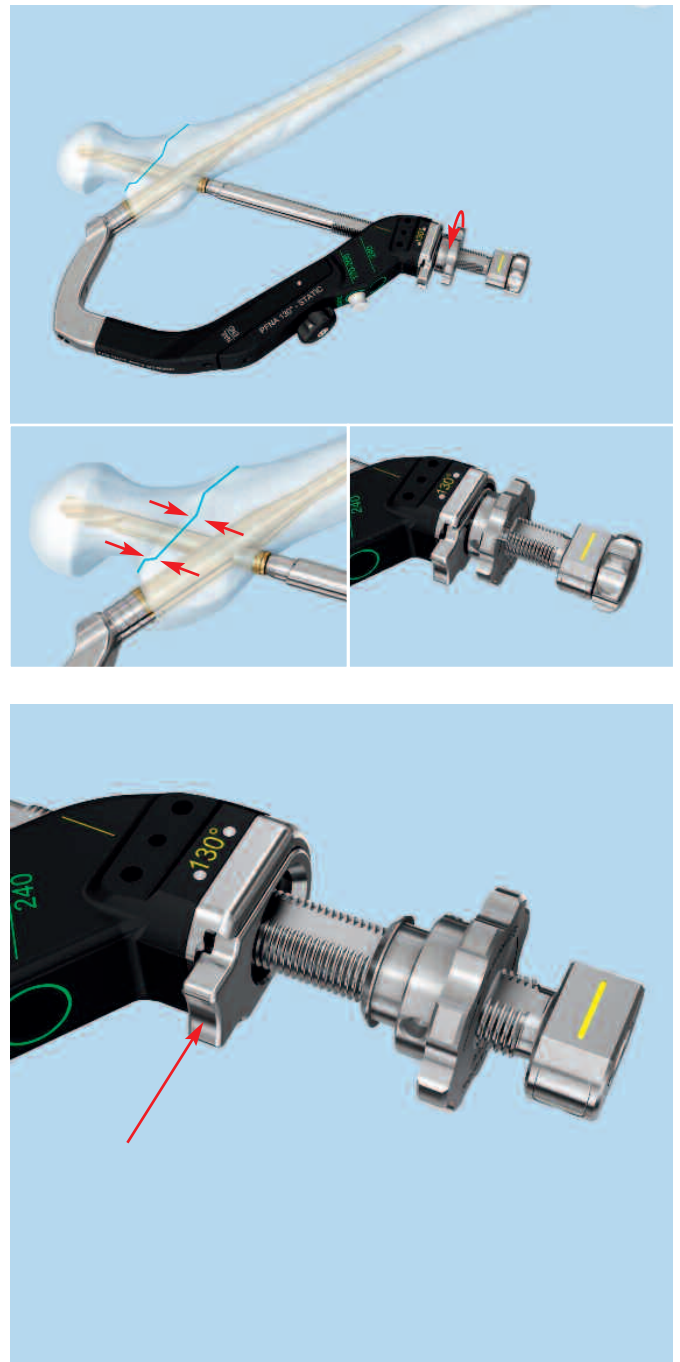

Distal Locking

Distal Locking for PFNA Short (Length 170 mm–240 mm)

Static or dynamic locking can be performed via the aiming arm with PFNA short (Length 170 mm–240 mm).

PFNA short

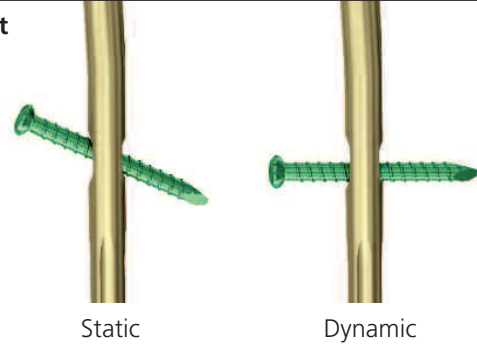

Distal Locking for PFNA Long (Length 300 mm–420 mm)

The PFNA long (Length 300 mm–420 mm) additionally allows for secondary dynamization.

Distal locking of PFNA long is performed with the freehand technique. Alternatively distal locking can be performed using the SureLock System and the corresponding technique guide (036.000.778).

PFNA long

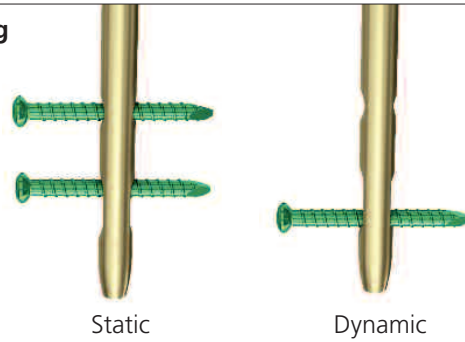

Locking implants for distal locking

Distal locking for PFNA described in this technique guide is using the 4.9 mm locking bolts and the corresponding instruments (68.027.002.03: Insert 1, for Ø 4.9 mm locking bolts, from instrument set 01.027.101).

Alternatively, the 5.0 mm locking screws from the Expert Nailing Systems can be used with the corresponding instruments (68.027.002.04: Insert 1, for Ø 5.0 mm locking screws, from instrument set 01.027.102) for distal locking of the PFNA.

See table below for corresponding instruments.

Short PFNA Nails (170 mm – 240 mm)

Locking Bolts Ø 4.9 mm		Locking Screws Ø 5.0 mm	
Part No.	Description	Part No.	Description
356.834	Drill Bit Ø 4.0 mm, for PFNA	03.010.061	Drill Bit Ø 4.2 mm, length 340 mm, for Quick Coupling
356.831	Protection Sleeve 11.0/8.0, green	03.025.040	Protection Sleeve 11.0/8.0
356.828	Drill Sleeve 8.0/4.0, green	03.010.065	Drill Sleeve 8.0/4.2
356.833	Trocar Ø 4.0 mm, green	03.010.070	Trocar Ø 4.2 mm
356.835	Measuring Device for Locking Bolt	03.010.428	Depth Gauge for Locking Screws
314.260	Screwdriver, hexagonal, large, Ø 3.5 mm, length 300 mm	03.010.107	Screwdriver Stardrive, T25, length 330 mm

Long PFNA Nails (300 mm – 420 mm)

Locking Bolts Ø 4.9 mm		Locking Screws Ø 5.0 mm	
Part No.	Description	Part No.	Description
356.834	Drill Bit Ø 4.0 mm, for PFNA	03.010.101	Drill Bit Ø 4.2 mm, length 145 mm, with Coupling for RDL
		03.010.104	Drill Bit Ø 4.2 mm, length 145 mm, for Quick Coupling
356.835	Measuring Device for Locking Bolt	03.010.019	Depth Gauge for Locking Screws, short
		03.010.429	Direct Measuring Device for Drill Bits of length 145 mm
314.260	Screwdriver, hexagonal, large, Ø 3.5 mm, length 300 mm	03.010.362	Screwdriver Stardrive, T25, length 275 mm
314.280	Holding Sleeve, large	03.010.112	Holding Sleeve, with Locking Device

Distal Locking

For PFNA Short

Distal Locking for PFNA Short (Length 170 mm–240 mm)

1

Choose aiming arm for distal locking

Distal locking of PFNA short is performed through the aiming arm (see steps 2 and 3). Choose an appropriate aiming arm according to the table below. Make sure the plug for aiming arm is inserted into the locking hole of the nail length that is NOT used in this case.

Nail length	Locking	Aiming arm	
170–240 mm	Static	03.010.406	Aiming Arm 125°, for PFNA Blade
170–240 mm	Static	03.010.407	Aiming Arm 130°, for PFNA Blade
170–240 mm	Static	03.010.408	Aiming Arm 135°, for PFNA Blade
170–240 mm	Dynamic	03.010.409	Aiming Arm, for dynamic locking of PFNA

2

Option A: Static distal locking of PFNA short

Instruments

356.831	Protection Sleeve 11.0/8.0, green
356.828	Drill Sleeve 8.0/4.0, green
356.833	Trocar Ø 4.0 mm, green

Using the hexagonal screwdriver with spherical head, confirm that the connecting screw between the insertion handle and the PFNA is sufficiently tightened.

Insert the three-part trocar combination (protection sleeve, drill sleeve and trocar) through the hole in the aiming arm that corresponds with the nail length, make a stab incision and insert the trocar to the bone. Remove the trocar.

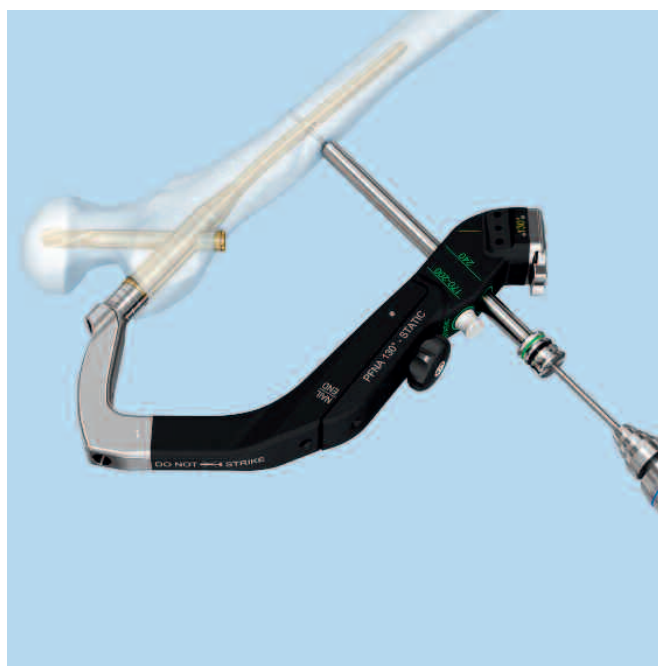

Option B: Dynamic distal locking of PFNA short

Instruments

03.010.409	PFNA Aiming Arm for dynamic locking
356.831	Protection Sleeve 11.0/8.0, green
356.828	Drill Sleeve 8.0/4.0, green
356.833	Trocar Ø 4.0 mm, green

Using the hexagonal screwdriver with spherical head, confirm that the connecting screw between the insertion handle and the PFNA is well tightened.

Remove the aiming arm for PFNA blade. Mount the aiming arm for dynamic locking and fix it firmly to the insertion handle.

Insert the three-part trocar combination (protection sleeve, drill sleeve and trocar) through the hole in the aiming arm that corresponds with the nail length, make a stab incision and insert the trocar to the bone. Remove the trocar.



3 Drill

Instrument

356.834 Drill Bit Ø 4.0 mm, for PFNA

Use the drill bit to drill through both cortices. The tip of the drill bit should protrude by 2 to 4 mm.

- ① Just after drilling both cortices, confirm the drill bit position.

Ensure that the drill sleeve is pressed firmly to the near cortex and read the measurement from the calibrated drill bit at the back of the drill sleeve. This measurement corresponds to the appropriate length of the locking bolt. Remove the drill bit and the drill sleeve.

Important: Always make sure that no diastasis has occurred intraoperatively before beginning distal locking. Diastasis can cause delayed healing. Always ensure that the connection between PFNA, insertion handle and aiming arm is good, otherwise drilling for distal locking may damage the PFNA.

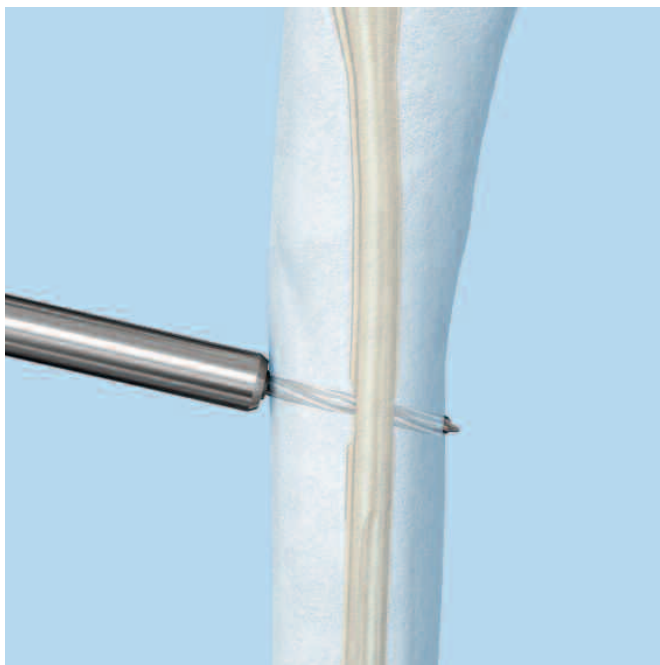

4

Determine length of the locking bolt

Instrument

356.835 Measuring Device for Locking Bolt

After drilling both cortices, remove the drill bit and the drill sleeve.

Advance the depth gauge through the protection sleeve and through both cortices. Draw back the hook until it engages in the opposite cortex. Read the measurement from the depth gauge. Add 2 to 4 mm to the measured length to ensure good engagement of the locking bolt in the opposite cortex.

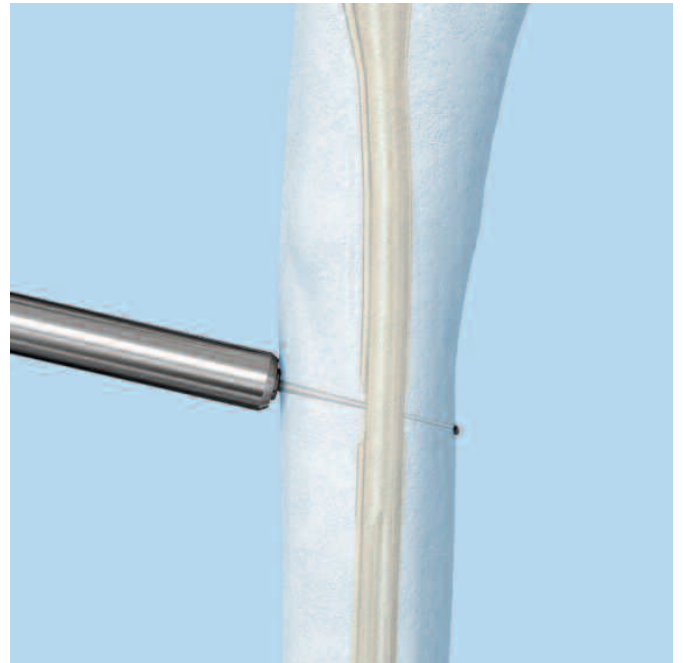

5

Insert locking bolt

Instrument

314.260 Screwdriver, hexagonal, large, Ø 3.5 mm,
with Groove, length 300 mm

Insert a locking bolt of the measured length with the hexagonal screwdriver through the protection sleeve until the locking bolt head lies against the near cortex. The tip of the locking bolt should not project more than 1–2 mm beyond the far cortex.

Remove the screwdriver and the protection sleeve.



Distal Locking

For PFNA Long

Distal Locking for PFNA Long (Length 300 mm–420 mm)

1

Align C-arm

- Check reduction, then correct alignment of the fragments and leg length before locking the nail.
- Align the C-arm with the hole in the nail until a perfect circle is visible in the center of the screen.

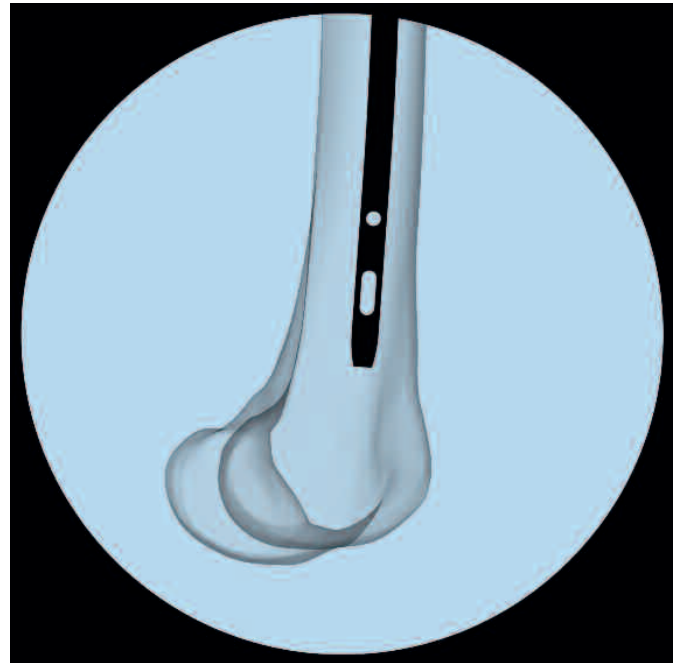

2

Determine incision point

- Place a guide wire on the skin over the center of the hole to mark the incision point and make a stab incision.

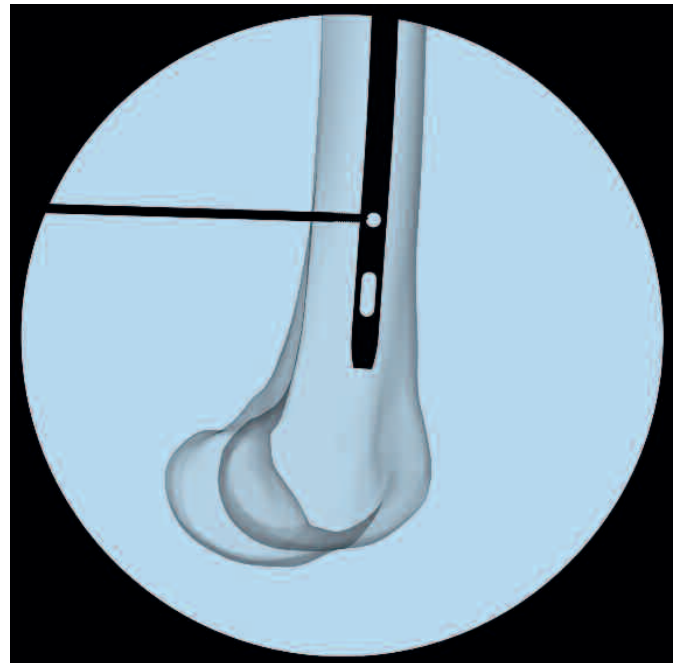

3 Drill

Option: Locking with ASLS

ASLS, the Angular Stable Locking System, can be used as an alternative to standard locking screws in any round hole of a Synthes cannulated titanium nail. For more details regarding the intramedullary fixator principle please consult the ASLS surgical technique (036.000.708) and concept flyer (036.001.017). Please note that for the use of ASLS special instruments are required.

Instrument

511.417	Drill Bit \varnothing 4.0 mm with centering tip, length 148/122 mm, 3-flute, with Coupling for RDL
---------	--

- Using the radiolucent drive (511.300), under image intensification, insert the tip of the drill bit through the incision down to the bone.

- Incline the drive in order that the tip of the drill bit is centered over the locking hole. The drill bit should almost completely fill the circle of the locking hole. Hold the drill bit in this position and drill through both cortices until the tip of the drill bit penetrates the medial far cortex.

Tip: For greater drill bit control, discontinue drill power after perforating the near cortex. Manually guide the drill bit through the nail before drilling the far cortex.

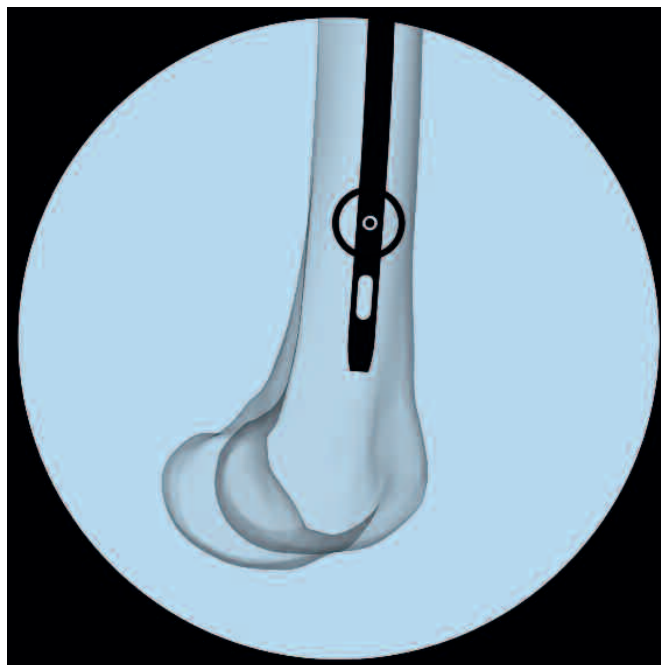
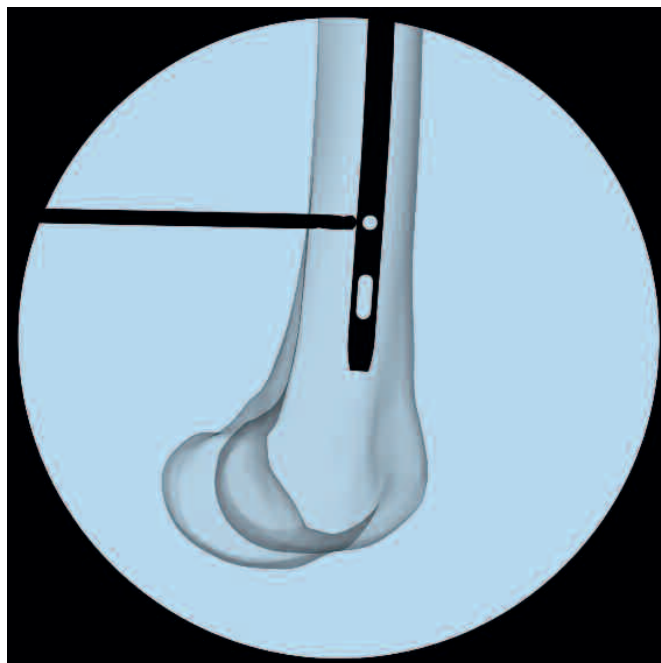

4

Determine length of the locking bolt and insert locking bolt

Instruments

356.835	Measuring Device for Locking Bolt
314.260	Screwdriver, hexagonal, large, \varnothing 3.5 mm, with Groove, length 300 mm
314.280	Holding Sleeve, large, for Nos. 314.190, 314.240, 314.260, 314.270 and 314.750

Measure the locking bolt length using the measuring device. Ensure that the outer sleeve is in contact with the bone and the hook grasps the far cortex. Add 2 to 4 mm to the measured length in order to ensure that the locking bolt is well engaged in the opposite cortex.

Insert the locking bolt with the appropriate length using the hexagonal screwdriver and the holding sleeve, if required.

- ① Verify the bolt length under image intensification. The bolt tip should be about 1–2 mm outside of the cortex. Exchange the locking bolt with the appropriate length if necessary.



Insert End Cap

1

Remove PFNA instruments

Instrument

03.023.011	Screwdriver, hexagonal with spherical head \varnothing 10.0 mm
------------	--

Remove the aiming arm. Loosen the connection screw with the hexagonal screwdriver with spherical head. Remove the connecting screw and the insertion handle.

Tip: The end cap with 0 mm extension can be inserted through the insertion handle barrel. Only remove the connecting screw and leave the insertion handle in place.



2

Insert end cap

Instruments

356.717	Guide Wire Ø 2.8 mm, length 460 mm, with Hook
03.023.001	Screwdriver Stardrive with spherical head, T40, cannulated, length 300 mm

If the proximal end of the nail is flush with the upper edge of the trochanter major use the end cap with 0 mm extension. Use the end cap with 5 to 15 mm extension to lengthen the nail end.

Insert the hook of the guide wire through the selected end cap. Guide the cannulated screwdriver over the guide wire to the end cap. The end cap is retained automatically as soon as this connection is established.

Screw the end cap into the proximal end of the nail and tighten it firmly.

Remove the screwdriver and the guide wire.



Implant Removal

1

Remove PFNA blade

Instruments

356.830	Guide Wire Ø 3.2 mm, for PFNA Blade
03.010.411	Extraction Screw for PFNA Blade
03.010.124	Combined Hammer 500 g, can be mounted
356.832	Key for PFNA Blade

Note: Implant removal is an elective procedure.

After an incision through the old scars, locate the PFNA blade by palpation or under image intensifier control. Insert the guide wire through the cannulated PFNA blade. Push the extraction screw over the guide wire and use gentle pressure to screw it counterclockwise into the PFNA blade (note "attach" marking on the extraction screw shaft).

Extract the PFNA blade by applying gentle blows with the hammer.

Tips

- If the extraction of the PFNA blade is difficult, remove the locking bolt and the end cap, screw the hammer guide into the PFNA and mobilize the nail to loosen the nail-blade connection.
- To detach the blade from the bone use light hammer blows to slightly drive in the blade before removal of the blade.



Use the key for PFNA blade to detach the blade from the extraction screw if necessary.

Note: If the removal of the PFNA blade is not possible with the standard instruments use the special instruments from the PFNA/PFNA-II Blade Extraction Set (01.010.181) and the corresponding technique guide (036.000.489).

2 Remove end cap

Instruments

356.717	Guide Wire \varnothing 2.8 mm, length 460 mm, with Hook
356.715	Socket, hexagonal, \varnothing 11.0/11.0 mm, cannulated, for AFN
321.160	Combination Wrench \varnothing 11.0 mm

Insert the hook of the guide wire with hook through the end cap. Guide the cannulated hexagonal socket over the guide wire to the end cap. Remove the end cap with the combination wrench.



3

Remove locking bolt and nail

Instruments

357.071	Hammer Guide, for No. 357.026
314.260	Screwdriver, hexagonal, large, Ø 3.5 mm, with Groove, length 300 mm
314.280	Holding Sleeve, large, for Nos. 314.190, 314.240, 314.260, 314.270 and 314.750
03.010.124	Combined Hammer 500 g, can be mounted

Before removing the locking bolt, screw the hammer guide into the PFNA and tighten it.

Remove the locking bolt with the hexagonal screwdriver. Mount the large holding sleeve onto the hexagonal screwdriver to facilitate removal of the locking bolt.

Note: If removal of the locking bolt is not possible and/or in case of broken locking bolts, the Screw Extraction Set and the corresponding handling technique (036.000.918) is recommended.

Extract the nail by applying gentle blows with the hammer.

Note: Remove the locking bolt after screwing the hammer guide into the PFNA. Thereby a rotation of the PFNA in the bone will be avoided.



Correction of Insertion Depth of PFNA Blade

Instruments

03.010.411	Extraction Screw for PFNA Blade
03.010.124	Combined Hammer 500 g, can be mounted

Remove the impactor if it is still in place. Insert the extraction screw over the guide wire and through the sleeve assembly using gentle counterclockwise pressure to attach the extraction screw to the PFNA blade (note "attach" marking).

Advance the now unlocked PFNA blade to the desired insertion depth by applying gentle blows with the combined hammer. In the AP and lateral view, the correct position of the PFNA blade is 10 mm below the joint level. Minimal distance to the joint is 5 mm. Turning the extraction screw clockwise to the stop (note "lock" marking) allows for relocking of the PFNA blade and removing the extraction screw.

- Verify PFNA blade locking intraoperatively.

Note: The PFNA blade is locked if all gaps are closed.

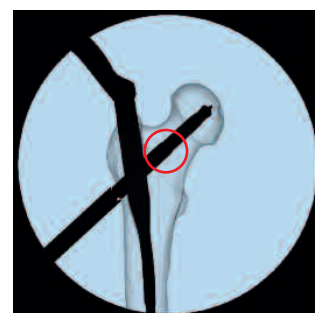
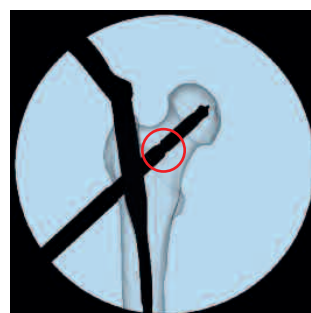
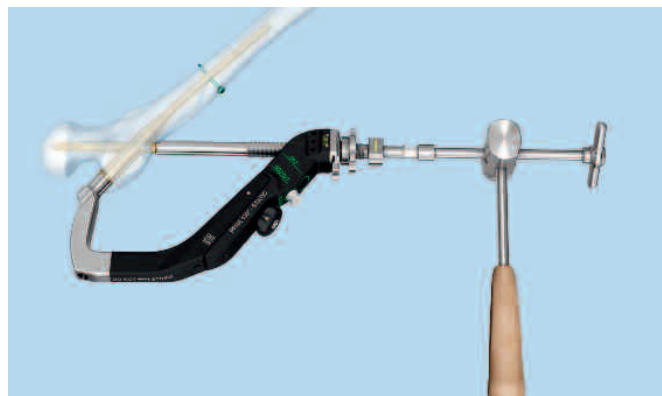

Cleaning

Intra- and postoperative cleaning

Instruments

319.460	Cleaning Stylet \varnothing 2.8 mm, for Cannulated Instruments
357.009	Cleaning Stylet \varnothing 2.8 mm, length 450 mm, for Cannulated Instruments

Use the 2.8 mm stylet or the long 2.8 mm cleaning stylet (length 450 mm) for intraoperative cleaning of the instrument cannulations.

PFNA Nails

Material:	Ti-6Al-7Nb (TAN), color: gold Stainless Steel
Diameters:	Proximal: Ø 16.5 mm (XS and small) Ø 17.0 mm (standard and long) Distal: Ø 9–12 mm with 1 mm increments (short nails) Ø 9, Ø 10, Ø 12, Ø 14 mm (long nails)
Lengths:	Short nails: 170 mm xs 200 mm small 240 mm standard (one nail for left and right) Long nails: 300 mm–420 mm (left and right nails, 20 mm increments)
CCD-Angle:	125° and 130° Additionally 135° for standard nails
Cannulation:	All nails are cannulated



PFNA Extra Small, length 170 mm

Distal diameter (mm)	Angle	TAN	SSt
9	125°	472.436S	272.436S
10	125°	472.385S	272.385S
11	125°	472.386S	272.386S
12	125°	472.387S	272.387S
9	130°	472.437S	272.437S
10	130°	472.390S	272.390S
11	130°	472.391S	272.391S
12	130°	472.392S	272.392S

**PFNA Small, length 200 mm**

Distal diameter (mm)	Angle	TAN	SSt
9	125°	472.430S	272.430S
10	125°	472.370S	272.370S
11	125°	472.371S	272.371S
12	125°	472.372S	272.372S
9	130°	472.431S	272.431S
10	130°	472.375S	272.375S
11	130°	472.376S	272.376S
12	130°	472.377S	272.377S

**PFNA, length 240 mm**

Distal diameter (mm)	Angle	TAN	SSt
9	125°	472.400S	–
10	125°	472.260S	272.260S
11	125°	472.261S	272.261S
12	125°	472.262S	272.262S
9	130°	472.401S	–
10	130°	472.265S	272.265S
11	130°	472.266S	272.266S
12	130°	472.267S	272.267S
10	135°	472.270S	272.270S
11	135°	472.271S	272.271S
12	135°	472.272S	272.272S



PFNA Ø 9.0 mm, long

Length (mm)	Angle	TAN		SSt	
		right	left	right	left
300	125°	04.023.100S	04.023.101S	02.023.100S	02.023.101S
320	125°	04.027.162S	04.027.163S	02.027.162S	02.027.163S
340	125°	472.410S	472.411S	272.410S	272.411S
360	125°	04.027.166S	04.027.167S	02.027.166S	02.027.167S
380	125°	04.027.168S	04.027.169S	272.416S	272.417S
400	125°	04.027.170S	04.027.171S	02.027.170S	02.027.171S
420	125°	04.027.172S	04.027.173S	272.422S	272.423S
300	130°	04.023.104S	04.023.105S	02.023.104S	02.023.105S
320	130°	04.027.182S	04.027.183S	02.027.182S	02.027.183S
340	130°	472.412S	472.413S	272.412S	272.413S
360	130°	04.027.186S	04.027.187S	02.027.186S	02.027.187S
380	130°	04.027.188S	04.027.189S	272.418S	272.419S
400	130°	04.027.190S	04.027.191S	02.027.190S	02.027.191S
420	130°	04.027.192S	04.027.193S	272.424S	272.425S

PFNA Ø 10.0 mm, long

Length (mm)	Angle	TAN		SSt	
		right	left	right	left
300	125°	04.023.102S	04.023.103S	02.023.102S	02.023.103S
320	125°	04.027.202S	04.027.203S	02.027.202S	02.027.203S
340	125°	472.275S	472.320S	272.275S	272.320S
360	125°	04.027.206S	04.027.207S	02.027.206S	02.027.207S
380	125°	472.290S	472.335S	272.290S	272.335S
400	125°	04.027.210S	04.027.211S	02.027.210S	02.027.211S
420	125°	472.305S	472.350S	272.305S	272.350S
300	130°	04.023.106S	04.023.107S	02.023.106S	02.023.107S
320	130°	04.027.222S	04.027.223S	02.027.222S	02.027.223S
340	130°	472.280S	472.325S	272.280S	272.325S
360	130°	04.027.226S	04.027.227S	02.027.226S	02.027.227S
380	130°	472.295S	472.340S	272.295S	272.340S
400	130°	04.027.230S	04.027.231S	02.027.230S	02.027.231S
420	130°	472.310S	472.355S	272.310S	272.355S



PFNA Ø 12.0 mm, long

Length (mm)	Angle	TAN		SSt	
		right	left	right	left
300	125°	04.027.240S	04.027.241S	02.027.240S	02.027.241S
320	125°	04.027.242S	04.027.243S	02.027.242S	02.027.243S
340	125°	04.027.244S	04.027.245S	02.027.244S	02.027.245S
360	125°	04.027.246S	04.027.247S	02.027.246S	02.027.247S
380	125°	04.027.248S	04.027.249S	02.027.248S	02.027.249S
400	125°	04.027.250S	04.027.251S	02.027.250S	02.027.251S
420	125°	04.027.252S	04.027.253S	02.027.252S	02.027.253S
300	130°	04.027.260S	04.027.261S	02.027.260S	02.027.261S
320	130°	04.027.262S	04.027.263S	02.027.262S	02.027.263S
340	130°	04.027.264S	04.027.265S	02.027.264S	02.027.265S
360	130°	04.027.266S	04.027.267S	02.027.266S	02.027.267S
380	130°	04.027.268S	04.027.269S	02.027.268S	02.027.269S
400	130°	04.027.270S	04.027.271S	02.027.270S	02.027.271S
420	130°	04.027.272S	04.027.273S	02.027.272S	02.027.273S

PFNA Ø 14.0 mm, long

Length (mm)	Angle	TAN		SSt	
		right	left	right	left
300	125°	04.027.280S	04.027.281S	02.027.280S	02.027.281S
320	125°	04.027.282S	04.027.283S	02.027.282S	02.027.283S
340	125°	04.027.284S	04.027.285S	02.027.284S	02.027.285S
360	125°	04.027.286S	04.027.287S	02.027.286S	02.027.287S
380	125°	04.027.288S	04.027.289S	02.027.288S	02.027.289S
400	125°	04.027.290S	04.027.291S	02.027.290S	02.027.291S
420	125°	04.027.292S	04.027.293S	02.027.292S	02.027.293S
300	130°	04.027.300S	04.027.301S	02.027.300S	02.027.301S
320	130°	04.027.302S	04.027.303S	02.027.302S	02.027.303S
340	130°	04.027.304S	04.027.305S	02.027.304S	02.027.305S
360	130°	04.027.306S	04.027.307S	02.027.306S	02.027.307S
380	130°	04.027.308S	04.027.309S	02.027.308S	02.027.309S
400	130°	04.027.310S	04.027.311S	02.027.310S	02.027.311S
420	130°	04.027.312S	04.027.313S	02.027.312S	02.027.313S



PFNA Blades

Material:	Ti-6Al-7Nb (TAN), color: gold Stainless Steel
Lengths:	75–130 mm (5 mm increments)
Cannulation:	All blades are cannulated

**PFNA Blades**

Length (mm)	TAN	SSt
75	04.027.010S	02.027.010S
80	04.027.011S	02.027.011S
85	04.027.012S	02.027.012S
90	04.027.013S	02.027.013S
95	04.027.014S	02.027.014S
100	04.027.015S	02.027.015S
105	04.027.016S	02.027.016S
110	04.027.017S	02.027.017S
115	04.027.018S	02.027.018S
120	04.027.019S	02.027.019S
125	04.027.020S	02.027.020S
130	04.027.021S	02.027.021S

PFNA End Caps

Used to protect nail threads from tissue ingrowth

Material:	Ti-6Al-7Nb (TAN), color: gold Stainless Steel
Lengths:	0 mm – sits flush with end of nail 5, 10 and 15 mm extensions – extend nail height if nail is overinserted
Cannulation:	All end caps are cannulated
Design:	Stardrive T40/hexagonal recess \varnothing 11 mm



PFNA End Caps

Extension (mm)	TAN	SSt
0	04.027.000S	02.027.000S
5	04.027.001S	02.027.001S
10	04.027.002S	02.027.002S
15	04.027.003S	02.027.003S

Locking Bolts

Material:	Ti-6Al-7Nb (TAN), color: light green Stainless Steel
Drill:	Ø 4.0 mm
Lengths:	26–60 mm (2 mm increments) 60–80 mm (4 mm increments) 80–100 mm (5 mm increments)
Design:	Hexagonal recess Ø 3.5 mm



Locking Bolt Ø 4.9 mm, self-tapping

Length (mm)	TAN*	SSt*
26	459.260	259.260
28	459.280	259.280
30	459.300	259.300
32	459.320	259.320
34	459.340	259.340
36	459.360	259.360
38	459.380	259.380
40	459.400	259.400
42	459.420	259.420
44	459.440	259.440
46	459.460	259.460
48	459.480	259.480
50	459.500	259.500
52	459.520	259.520

Length (mm)	TAN*	SSt*
54	459.540	259.540
56	459.560	259.560
58	459.580	259.580
60	459.600	259.600
64	459.640	259.640
68	459.680	259.680
72	459.720	259.720
76	459.760	259.760
80	459.800	259.800
85	459.850	259.850
90	459.900	259.900
95	459.950	259.950
100	459.960	259.960

*Available non-sterile or sterile packed. Add "S" to the article number to order sterile products.

Alternative Implants

PFNA Blades

Material: Ti-6Al-7Nb (TAN), color: gold
Stainless Steel

Lengths: 80–120 mm (5 mm increments)

Cannulation: All blades are cannulated



PFNA Blades

Length (mm)	TAN	SSt
80	456.712S	256.712S
85	456.713S	256.713S
90	456.714S	256.714S
95	456.715S	256.715S
100	456.716S	256.716S
105	456.717S	256.717S
110	456.718S	256.718S
115	456.719S	256.719S
120	456.720S	256.720S

PFNA End Caps

Used to protect nail threads from tissue ingrowth

Material:	Ti-6Al-7Nb (TAN), color: gold Stainless Steel
Lengths:	0 mm – sits flush with end of nail 5, 10 and 15 mm extensions – extend nail height if nail is overinserted
Cannulation:	All end caps are cannulated
Design:	Hexagonal recess \varnothing 4.0 mm/ \varnothing 11.0 mm

**PFNA End Caps**

Extension (mm)	TAN	SSt
0	473.155S	273.155S
5	473.156S	273.156S
10	473.157S	273.157S
15	473.158S	273.158S

Locking Screws

Material: Ti-6Al-7Nb (TAN), color: light green

Drill: Ø 4.2 mm

Lengths: 26 mm–80 mm (2 mm increments)
85 mm–100 mm (5 mm increments)

Design: Stardrive T25 recess

Locking Screw Stardrive Ø 5.0 mm, for Medullary Nails

Length (mm)	TAN*
26	04.005.516
28	04.005.518
30	04.005.520
32	04.005.522
34	04.005.524
36	04.005.526
38	04.005.528
40	04.005.530
42	04.005.532
44	04.005.534
46	04.005.536
48	04.005.538
50	04.005.540
52	04.005.542
54	04.005.544
56	04.005.546

Length (mm)	TAN*
58	04.005.548
60	04.005.550
62	04.005.552
64	04.005.554
66	04.005.556
68	04.005.558
70	04.005.560
72	04.005.562
74	04.005.564
76	04.005.566
78	04.005.568
80	04.005.570
85	04.005.575
90	04.005.580
95	04.005.585
100	04.005.590

*Available non-sterile or sterile packed. Add "S" to the article number to order sterile products.

Instruments

309.600 Drill Bit \varnothing 17.0 mm, cannulated, for PFNA



309.602 Radiographic Ruler for PFNA



309.603 Drill Sleeve 17.0/3.2, for No. 357.001



314.260 Screwdriver, hexagonal, large, \varnothing 3.5 mm, with Groove, length 300 mm



314.280 Holding Sleeve, large, for Nos. 314.190, 314.240, 314.260, 314.270 and 314.750



321.160 Combination Wrench \varnothing 11.0 mm



321.170 Pin Wrench \varnothing 4.5 mm, length 120 mm



356.715 Socket, hexagonal, \varnothing 11.0/11.0 mm, cannulated, for AFN











356.717 Guide Wire \varnothing 2.8 mm, length 460 mm, with Hook

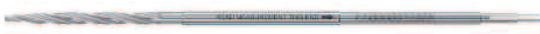









356.817 Buttress/Compression Nut, for PFNA Blade



356.818	Protection Sleeve 16.0/11.0 for PFNA Blade	
356.819	Drill Sleeve 11.0/3.2, for PFNA Blade	
356.820	Trocar Ø 3.2 mm, for PFNA Blade, gold	
356.821	Reamer Ø 11 mm, for PFNA Blade	
356.822	Drill Bit Ø 11 mm, for PFNA Blade	
356.826	Aiming Jig for Anti-rotation Wire	
356.827	Drill Sleeve 5.6/3.2, for No. 356.826	
356.828	Drill Sleeve 8.0/4.0, green	
356.829	Direct Measuring Device for Guide Wire Ø 3.2 mm	

356.830	Guide Wire Ø 3.2 mm, for PFNA Blade	
356.831	Protection Sleeve 11.0/8.0, green	
356.832	Key for PFNA Blade	
356.833	Trocar Ø 4.0 mm, green	
356.834	Drill Bit Ø 4.0 mm, for PFNA	
356.835	Measuring Device for Locking Bolt	
357.001	Protection Sleeve 20.0/17.0, for No. 357.005	
357.029	Connecting Screw, cannulated, for PFN	
357.046	Fixation Sleeve, for No. 357.045	
357.071	Hammer Guide, for No. 357.026	

393.100	Universal Chuck with T-Handle	
03.010.124	Combined Hammer 500 g, can be mounted, for No. 357.117	
03.010.405	Insertion Handle, radiolucent, for PFNA	
03.010.407	Aiming Arm 130°, for PFNA Blade	
03.010.410	Impactor for PFNA Blade	
03.010.411	Extraction Screw for PFNA Blade	
03.010.423	Compression Instrument for PFNA Blade	
03.010.424	Connector for Insertion Handle for PFNA	
03.010.470	Plug for Aiming Arm	
03.023.001	Screwdriver Stardrive with spherical head, T40, cannulated, length 300 mm	
03.023.011	Screwdriver, hexagonal with spherical head Ø 10.0 mm, cannulated	

Optional instruments

319.970 Screw Forceps, self-holding, length 85 mm



351.050 Tissue Protector



356.830S Guide Wire Ø 3.2 mm, for PFNA Blade, sterile



357.009 Cleaning Stylet Ø 2.8 mm, length 450 mm, for Cannulated Instruments



03.010.019 Depth Gauge for Locking Screws, short



03.010.362 Screwdriver Stardrive, T25, length 275 mm



03.010.406 Aiming Arm 125°, for PFNA Blade



03.010.408 Aiming Arm 135°, for PFNA Blade



03.010.409 PFNA Aiming Arm for dynamic locking



03.010.412 Aiming Device for Guide Wire, for PFNA and TFN, for AP Orientation



03.010.414 Connecting Screw for PFNA, for No. 03.010.412



03.023.002 Protection Sleeve 20.0/17.0, for PFNA-II



03.023.003 Awl for PFNA-II



03.023.004 Aiming Arm for static locking, for PFNA-II small and extra-small



03.023.006 Drill Sleeve, for PFNA-II



03.023.010 Drill Bit Ø 16.5 mm, cannulated, flexible, for PFNA-II



Alternative instruments

314.050 Screwdriver, hexagonal, cannulated, for Cannulated Screws Ø 6.5 and 7.3 mm













321.200 Ratchet Wrench for Nut, hexagonal, 11.0 mm



356.714	Socket, hexagonal, \varnothing 4.0/11.0 mm, cannulated, for AFN	
356.810	Aiming Arm 125°, for PFNA Blade	
356.811	Aiming Arm 130°, for PFNA Blade	
356.812	Aiming Arm 135°, for PFNA Blade	
356.813	Aiming Arm for PFNA Blade 125°, for small and extra-small PFNA	
356.814	Aiming Arm for PFNA Blade 130°, for small and extra-small PFNA	
356.823	Impactor for PFNA Blade	
356.824	PFNA Aiming Arm for dynamic locking	
356.825	Extraction Screw for PFNA Blade	
357.012	Insertion Handle for PFN	

357.013	Thread Gland for Hammer Guide, for No. 357.012	
357.020	Insertion Handle for PFN and PFNA	
357.021	Connecting Screw for PFN, for no. 357.012	
357.023	Wrench, hexagonal, with T-Handle, for No. 357.021	
357.026	Slotted Hammer 400 g, can be mounted	
357.027	Socket, hexagonal, with T-Handle, short	
357.028	Connector for PFN, for No. 357.020	
399.420	Hammer 500 g	
03.025.040	Protection Sleeve 11.0/8.0, length 188 mm	
03.010.061	Drill Bit \varnothing 4.2 mm, calibrated, length 340 mm, 3-flute, for Quick Coupling, for No. 03.010.065	

03.010.065	Drill Sleeve 8.0/4.2, for No. 03.010.063	
03.010.070	Trocar Ø 4.2 mm, for No. 03.010.065	
03.010.101	Drill Bit Ø 4.2 mm, calibrated, length 145 mm, 3-flute, with Coupling for RDL	
03.010.104	Drill Bit Ø 4.2 mm, calibrated, length 145 mm, 3-flute, for Quick Coupling	
03.010.107	Screwdriver Stardrive, T25, length 330 mm	
03.010.112	Holding Sleeve, with Locking Device	
03.010.125	PFNA Aiming Arm for dynamic locking, for PFNA small and extra-small	
03.010.126	Wrench, hexagonal with T-handle	
03.010.428	Depth Gauge for Locking Screws, measuring range up to 110 mm, for No. 03.010.063	
03.010.429	Direct Measuring Device for Drill Bits of length 145 mm, for Nos. 03.010.100 to 03.010.105	

Cases

Vario Cases

01.027.101 Instrument for PFNA for \varnothing 4.9 mm Locking Bolts in Vario Case

68.027.001 Vario Case for PFNA Instrument Set (part 1), without Lid, without Contents

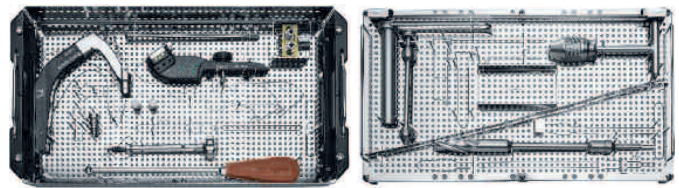

68.027.002 Vario Case for PFNA Instrument Set (part 2), without Lid, without Contents

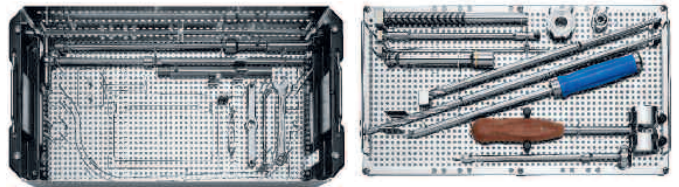

68.027.002.02 Insert 1, for \varnothing 4.9 mm Locking Bolts, for PFNA Instrument Set (part 2), vor Vario Case No. 68.027.002

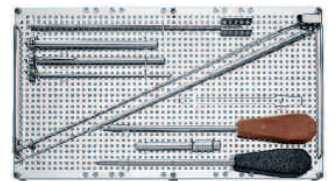

01.027.102 Instrument for PFNA for Ø 5.0 mm Locking Screws in Vario Case

68.027.001 Vario Case for PFNA Instrument Set (part 1), without Lid, without Contents

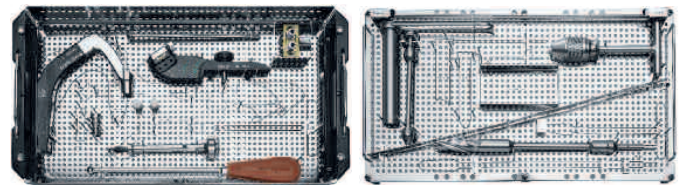

68.027.002 Vario Case for PFNA Instrument Set (part 2), without Lid, without Contents

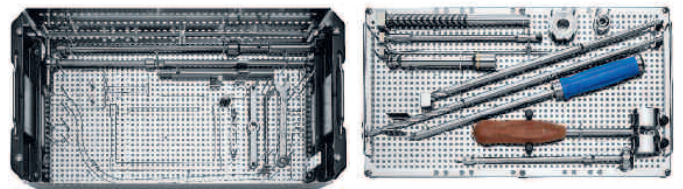

68.027.002.03 Insert 1, for Ø 5.0 mm Locking Screws, for PFNA Instrument Set (part 2), vor Vario Case No. 68.027.002

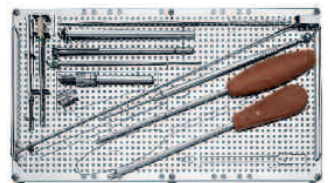

Optional

68.027.003 Rack for Locking Implants Ø 4.9 mm or Ø 5.0 mm, for Vario Case



689.507 Lid (Stainless Steel), size 1/1, for Vario Case



SynCases

01.027.110 Instrument for PFNA-II for \varnothing 4.9 mm Locking Bolts in SynCase

68.027.010 SynCase for Instrument for PFNA-II (part 1)

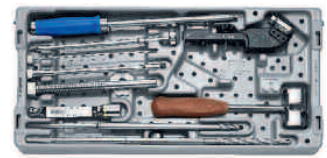
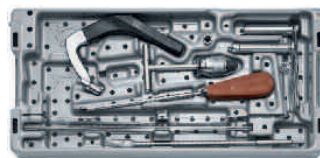

68.027.020 SynCase for Instrument for PFNA-II (part 2)

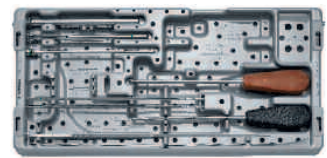
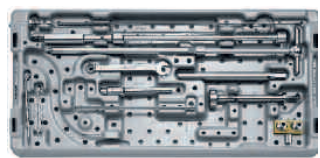

01.027.120 Instrument for PFNA-II for \varnothing 5.0 mm Locking Screws in SynCase

68.027.010 SynCase for Instrument for PFNA-II (part 1)

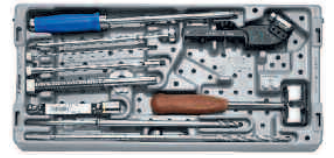

68.027.020 SynCase for Instrument for PFNA-II (part 2)

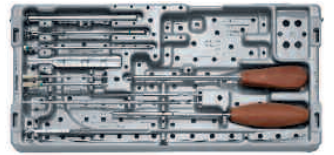
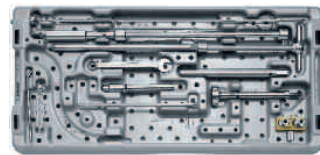

Power Tools

05.001.201	Battery Handpiece, modular, for Trauma Recon System
05.001.202	Power Module, for Trauma Recon System
05.001.203	Sterile Cover, for Trauma Recon System
05.001.204	Universal Battery Charger II
05.001.227	Lid for Battery Handpiece No. 05.001.201, for Trauma Recon System
05.001.205	AO/ASIF Quick Coupling, for Trauma Recon System
05.001.207	Drill Chuck (Reaming Speed), with Key, for Trauma Recon System, clamping range up to \varnothing 7.3 mm
05.001.210	Attachment for Acetabular and Medullary Reaming, for Trauma Recon System
05.001.212	Quick Coupling for Kirschner Wires \varnothing 1.0 to 4.0 mm, for Trauma Recon System
05.001.213	Quick Coupling for DHS/DCS Triple Reamers, for Trauma Recon System
05.001.226	Adapter for RDL, for Trauma Recon System
511.300	Radiolucent Drive



Optional: Angular Stable Locking System (ASLS)

What is ASLS?

The Angular Stable Locking System (ASLS) provides the ability to create a fixed-angle construct to an intramedullary nail. Therefore, it combines the advantages of angular stability and a minimally invasive approach. ASLS together with an intramedullary nail form the principle of the Intramedullary Fixator.

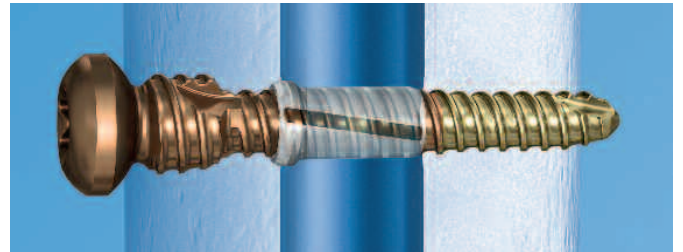

How does ASLS work?

The system consists of a screw with three outer diameters and a resorbable sleeve.

The resorbable sleeve is placed on the screw tip which has the smallest screw diameter and is pushed into the locking hole of the nail.

During screw advancement, the resorbable sleeve is expanded by the larger middle diameter. Radial expansion of the sleeve and its fixation in the nail creates the angular stability.

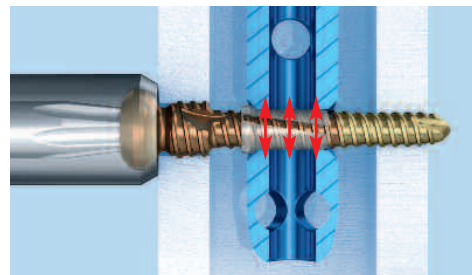
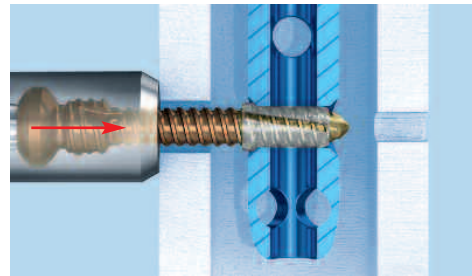

ASLS screws

- Titanium alloy*
- Screws ASLS4: Length 26 mm–80 mm, are compatible with Expert Adolescent Lateral Femoral Nails
- Fully threaded shaft with 3 diameters
 - D1: Provides purchase in reamed near cortex
 - D2: Expands sleeve, providing angular stability
 - D3: Holds unexpanded sleeve for screw insertion, provides purchase in far cortex
- T25 Stardrive recess
- Sterile packaged



ASLS sleeves

- 70:30 poly (L-lactide-co-D,L-lactide)
- Bioresorbable, provides 80% decreased fracture site motion during first 12 weeks of healing
- Gradually degrades within 2 years (resorption rate varies per patient and implant site)
- Inner thread for secure fit to screw
- Expands in nail locking hole
- Available in diameters of 4.0 mm (ASLS4), 5.0 mm (ASLS5) and 6.0 mm (ASLS6)
- Sterile-packed



Note: For more details regarding the intramedullary fixator principle please consult the ASLS surgical technique (036.000.708) and concept flyer (036.001.017).

*Titanium-6% aluminum-7% niobium alloy

Bibliography

Al-yassari G, Langstaff RJ, Jones JWM, Al-Lami M (2002) The AO/ASIF Proximal Femoral Nail (PFN) for the Treatment of Unstable Trochanteric Femoral Fractures. *Injury, Int. J. Care Injured* 33:395–399

Baumgaertner MR, Curtin SL, Lindskog DM, Keggi JM (1995) The Value of the Tip-Apex Distance in Predicting Failure of Fixation of Peritrochanteric Fractures of the Hip. *The Journal of Bone and Joint Surgery* vol. 77(7):1058–1064

Dora C, Leunig M, Beck M, Rothenfluh D, Ganz R (2001) Entry point soft tissue damage in antegrade femoral nailing : a cadaver study. *Journal of Orthopedic Trauma* Vol. 15, No. 7:488–493

Gautier E, Ganz K, Krügel N, Gill T, Ganz R (2000) Anatomy of the medial femoral circumflex artery and its surgical implications. *The Journal of Bone and Joint Surgery* Vol. 82-B, No. 5

Haas NP, Schütz M, Mauch C, Hoffmann R, Südkamp NP (1995) Treatment of ipsilateral fractures of the femur shaft and the proximal femur-review of the therapies and current management [d]. *Zentralblatt für Chirurgie* 120:856–861

Koot VCM, Peeters PHM, De Jong JR, Clevers Geert J, Van der Werken CHR (2000) Functional Results after Treatment of Hip Fracture: a Multicenter, Prospective Study in 215 Patients. *European Journal of Surgery*; 166:480–485

Nishiura T, Nozowa M, Morio H (2009) the new technique of precise insertion of lag screw in an operative treatment of trochanteric femoral fractures with a short intramedullary nail. *Injury, Int. J. Care injured* 40, 1077-1083

Regazzoni P Method of Treatment of Proximal Femoral Fractures; Choice of the Implant. *Proximal Femoral Fractures, Volume 2, Chapter 7 Part III*

Saudan M, Lübbecke A, Sadowski CHR, Riand N, Stern R, Hoffmeyer P Peritrochanteric Fractures – Is there an Advantage to an Intramedullary Nail? *Journal of Orthopaedic Trauma* Vol. 16, No. 6:386–393

Schipper IB, Steyerberg EW, Castelein RM, Van der Heijden FHWK, P. T. den Hoed, A. J. H. Kerver, A. B. Van Vugt J (2004) Bone Treatment of unstable trochanteric fractures. Randomised comparison of the Gaa Nail and the Proximal Femoral Nail. *Joint Surg [Br]* 86-B:86–94

Simmermacher RKJ, Ljungqvist J, Bail H, Hockertz T, Vochteloo AJH, U Ochs, Van der Werken CHR (2008) The new proximal femoral nail antirotation (PFNA) in daily practice: Results of a multicentre clinical study. *Injury* 39(8): 923–939

Simmermacher RKJ, Bosch AM, Van der Werken CHR, (1999) The AO/ASIF-proximal femoral nail (PFN) a new device for the treatment of unstable proximal femoral fractures. *Injury* 340:327–332

Strand RM, Molster AO, Engesaeter LB, Gjerdet NR, Orner T (1995/1998) Mechanical effects of different localization of the point of entry in femoral nailing. *J Bone Joint Surg Am. Jul 77(7):58-64 / Arch Orthop Trauma Surg* 117:35–38

Van Vugt AB Osteosynthesis versus Endoprosthesis in Treatment of unstable Intracapsular Hip Fractures in the Elderly. *A Randomised Clinical Trial Proximal Femoral Fractures, Volume 2, Chapter 17*



Synthes GmbH
Eimattstrasse 3
CH-4436 Oberdorf
www.depuysynthes.com



This publication is not intended for distribution in the USA.

All surgical techniques are available as PDF files
at www.synthes.com/lit

